

# **ENFRIAMIENTO**

# ENFRIAMIENTO

## **2024**

**@OptimoMx**  
**www.optimoautopartes.com**

 **ISAKA**  
GENUINE AUTO PARTS



|                             |                 |
|-----------------------------|-----------------|
| <b>CV</b>                   |                 |
| <b>ASTRA 1.8L 2006-2009</b> |                 |
| CÓDIGO:                     | <b>CRNC1410</b> |
| EQUIV 1:                    |                 |
| EQUIV 2:                    |                 |
| OEM:                        | 1300265         |
|                             |                 |

RADIADOR AGUA C/S AIRE AUT 600\*370\*16MM T/SOLDADO



|                            |                 |
|----------------------------|-----------------|
| <b>CV</b>                  |                 |
| <b>AVEO 1.5L 2018-2023</b> |                 |
| CÓDIGO:                    | <b>CRNC9980</b> |
| EQUIV 1:                   |                 |
| EQUIV 2:                   |                 |
| OEM:                       | 26693012        |
|                            |                 |

RADIADOR AGUA C/S AIRE STD 520\*400\*16MM T/MECANICO



|                            |                 |
|----------------------------|-----------------|
| <b>CV</b>                  |                 |
| <b>AVEO 1.5L 2018-2023</b> |                 |
| CÓDIGO:                    | <b>CRNC9981</b> |
| EQUIV 1:                   |                 |
| EQUIV 2:                   |                 |
| OEM:                       | 26693012        |
|                            |                 |

RADIADOR AGUA C/S AIRE STD 520\*400\*16MM T/SOLDADO



|                            |                  |
|----------------------------|------------------|
| <b>CV</b>                  |                  |
| <b>AVEO 1.6L 2007-2009</b> |                  |
| CÓDIGO:                    | <b>CRNC9900</b>  |
| EQUIV 1:                   | DPI-2774AT/35925 |
| EQUIV 2:                   |                  |
| OEM:                       | 96536524         |
|                            |                  |

RADIADOR AGUA S/AIRE AUT 500\*440\*16MM (PT G3 06-09) T/SOLDADO



|                            |                  |
|----------------------------|------------------|
| <b>CV</b>                  |                  |
| <b>AVEO 1.6L 2007-2009</b> |                  |
| CÓDIGO:                    | <b>CRNC9910</b>  |
| EQUIV 1:                   | DPI-2873AT/36097 |
| EQUIV 2:                   |                  |
| OEM:                       | 96443479         |
|                            |                  |

RADIADOR AGUA C/AIRE AUT 610\*440\*16MM (PT G3 06-09) T/SOLDADO

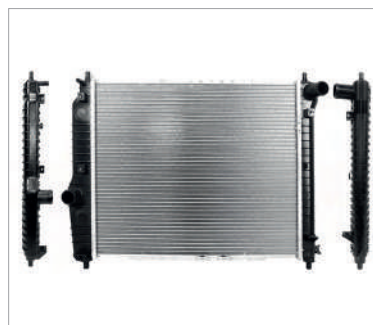

|                            |                 |
|----------------------------|-----------------|
| <b>CV</b>                  |                 |
| <b>AVEO 1.6L 2007-2009</b> |                 |
| CÓDIGO:                    | <b>CRNC9920</b> |
| EQUIV 1:                   | DPI-2774MT      |
| EQUIV 2:                   |                 |
| OEM:                       | 96444386        |
|                            |                 |

RADIADOR AGUA S/AIRE STD 500\*440\*16MM (PT G3 06-09) T/SOLDADO

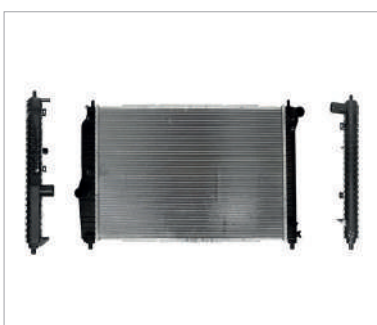

|                            |                 |
|----------------------------|-----------------|
| <b>CV</b>                  |                 |
| <b>AVEO 1.6L 2007-2009</b> |                 |
| CÓDIGO:                    | <b>CRNC9930</b> |
| EQUIV 1:                   | DPI-2873MT      |
| EQUIV 2:                   |                 |
| OEM:                       | 96536525        |
|                            |                 |

RADIADOR AGUA C/AIRE STD 610\*440\*16MM (PT G3 06-09) T/SOLDADO



|                            |                 |
|----------------------------|-----------------|
| <b>CV</b>                  |                 |
| <b>AVEO 1.6L 2010-2012</b> |                 |
| CÓDIGO:                    | <b>CRNC9940</b> |
| EQUIV 1:                   |                 |
| EQUIV 2:                   |                 |
| OEM:                       | 95227750        |
|                            |                 |

RADIADOR AGUA C/S AIRE STD 610\*420\*26MM T/SOLDADO



|                            |                 |
|----------------------------|-----------------|
| <b>CV</b>                  |                 |
| <b>AVEO 1.6L 2010-2012</b> |                 |
| CÓDIGO:                    | <b>CRNC9950</b> |
| EQUIV 1:                   | DPI-13097/36096 |
| EQUIV 2:                   |                 |
| OEM:                       | 95227754        |
|                            |                 |

RADIADOR AGUA C/S AIRE AUT 610\*420\*26MM T/SOLDADO

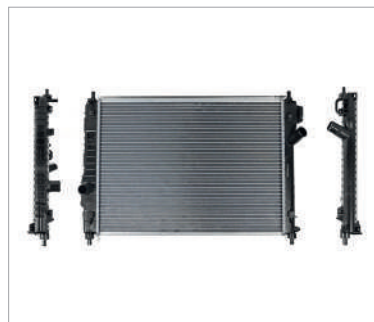

|                            |                 |
|----------------------------|-----------------|
| <b>CV</b>                  |                 |
| <b>AVEO 1.6L 2013-2017</b> |                 |
| CÓDIGO:                    | <b>CRNC9960</b> |
| EQUIV 1:                   | 36097           |
| EQUIV 2:                   |                 |
| OEM:                       | 95090813        |
|                            |                 |

RADIADOR AGUA C/S AIRE STD 610\*420\*16MM T/SOLDADO



|                            |                 |
|----------------------------|-----------------|
| <b>CV</b>                  |                 |
| <b>AVEO 1.6L 2013-2017</b> |                 |
| CÓDIGO:                    | <b>CRNC9970</b> |
| EQUIV 1:                   | 36097AU         |
| EQUIV 2:                   |                 |
| OEM:                       | 95090814        |
|                            |                 |

RADIADOR AGUA C/S AIRE AUT 610\*420\*16MM T/SOLDADO



|                                |                   |
|--------------------------------|-------------------|
| <b>CV</b>                      |                   |
| <b>CAVALIER 2.2L 2002-2005</b> |                   |
| CÓDIGO:                        | <b>CRNC4810</b>   |
| EQUIV 1:                       | DPI-2518/36105    |
| EQUIV 2:                       |                   |
| OEM:                           | 22661209/52381211 |
|                                |                   |

RADIADOR AGUA C/S AIRE AUT 680\*390\*26MM (SUNFIRE 03-05) T/SOLDADO



|                                     |                   |
|-------------------------------------|-------------------|
| <b>CV</b>                           |                   |
| <b>CAVALIER 2.2L/2.4L 1995-2001</b> |                   |
| CÓDIGO:                             | <b>CRNC4800</b>   |
| EQUIV 1:                            | DPI-1687/35534    |
| EQUIV 2:                            |                   |
| OEM:                                | 52463624/52470924 |
|                                     |                   |

RADIADOR AGUA C/S AIRE AUT 680\*410\*26MM (SUNFIRE 92-02) T/SOLDADO



|                                  |                 |
|----------------------------------|-----------------|
| <b>CV</b>                        |                 |
| <b>CHEVY 1.4L/1.6L 1994-2012</b> |                 |
| CÓDIGO:                          | <b>CRNC0100</b> |
| EQUIV 1:                         | 35518           |
| EQUIV 2:                         |                 |
| OEM:                             | 93244719        |
|                                  |                 |

RADIADOR AGUA S/AIRE STD 540\*280\*32MM (C-2/C-3) T/MECANICO



|                                  |                   |
|----------------------------------|-------------------|
| <b>CV</b>                        |                   |
| <b>CHEVY 1.4L/1.6L 1994-2012</b> |                   |
| CÓDIGO:                          | <b>CRNC0150</b>   |
| EQUIV 1:                         | 1300152           |
| EQUIV 2:                         |                   |
| OEM:                             | 93242169/52459322 |
|                                  |                   |

RADIADOR AGUA C/AIRE STD 690\*270\*32MM (C-2/C-3) T/MECANICO



|                                  |                 |
|----------------------------------|-----------------|
| <b>CV</b>                        |                 |
| <b>CHEVY 1.4L/1.6L 1994-2012</b> |                 |
| CÓDIGO:                          | <b>CRNC0160</b> |
| EQUIV 1:                         | 35634           |
| EQUIV 2:                         |                 |
| OEM:                             | 1300153         |
|                                  |                 |

RADIADOR AGUA C/AIRE AUT 690\*270\*32MM (C-2/C-3) T/MECANICO



|                                  |                 |
|----------------------------------|-----------------|
| <b>CV</b>                        |                 |
| <b>CORSA 1.4L/1.8L 2003-2008</b> |                 |
| CÓDIGO:                          | <b>CRNC0200</b> |
| EQUIV 1:                         | 35800/24445163  |
| EQUIV 2:                         |                 |
| OEM:                             | 93382157        |
|                                  |                 |

RADIADOR AGUA C/S AIRE STD 560\*380\*22MM (TORNADO 04-11) T/MECANICO

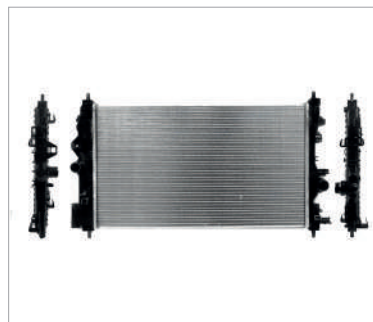

|                                  |                 |
|----------------------------------|-----------------|
| <b>CV</b>                        |                 |
| <b>CRUZE 1.4L/1.8L 2010-2015</b> |                 |
| CÓDIGO:                          | <b>CRNC1000</b> |
| EQUIV 1:                         | DPI-13198       |
| EQUIV 2:                         |                 |
| OEM:                             | 13267650        |
|                                  |                 |

RADIADOR AGUA C/S AIRE STD 700\*410\*26MM T/SOLDADO

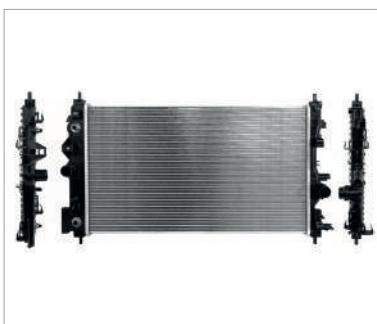

|                                  |                   |
|----------------------------------|-------------------|
| <b>CV</b>                        |                   |
| <b>CRUZE 1.4L/1.8L 2010-2015</b> |                   |
| CÓDIGO:                          | <b>CRNC1010</b>   |
| EQUIV 1:                         | DPI-13197         |
| EQUIV 2:                         |                   |
| OEM:                             | 13311079/13267652 |
|                                  |                   |

RADIADOR AGUA C/S AIRE AUT 700\*410\*26MM T/SOLDADO



|                               |                 |
|-------------------------------|-----------------|
| <b>CV</b>                     |                 |
| <b>EQUINOX 3.4L 2005-2005</b> |                 |
| CÓDIGO:                       | <b>CRNC3400</b> |
| EQUIV 1:                      | DPI-2764/35945  |
| EQUIV 2:                      |                 |
| OEM:                          | 15246426        |
|                               |                 |

RADIADOR AGUA C/S AIRE AUT 680\*460\*26MM T/SOLDADO



|  |                 |
|--|-----------------|
| <b>CV</b>                              |                 |
| <b>EXPRESS VAN 4.8L/6.0L 2003-2019</b> |                 |
| CÓDIGO:                                | <b>CRNC1200</b> |
| EQUIV 1:                               | DPI-2791/36084  |
| EQUIV 2:                               |                 |
| OEM:                                   | 23193133        |
|  |                 |

RADIADOR AGUA C/S AIRE AUT 860\*440\*26MM T/SOLDADO

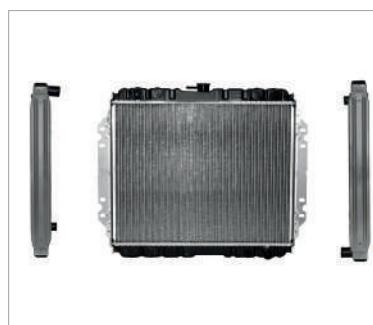

|                           |                  |
|---------------------------|------------------|
| <b>CV</b>                 |                  |
| <b>LUV 2.3L 1997-2005</b> |                  |
| CÓDIGO:                   | <b>CRNC2910</b>  |
| EQUIV 1:                  | 95706            |
| EQUIV 2:                  |                  |
| OEM:                      | 8-97088-182-2 AL |
|                           |                  |

RADIADOR AGUA S/AIRE STD 560\*440\*26MM T/SOLDADO



|                              |                 |
|------------------------------|-----------------|
| <b>CV</b>                    |                 |
| <b>MALIBU 2.2L 2004-2007</b> |                 |
| CÓDIGO:                      | <b>CRNC3010</b> |
| EQUIV 1:                     | DPI-2765/35947  |
| EQUIV 2:                     |                 |
| OEM:                         | 52486987        |
|                              |                 |

RADIADOR AGUA C/S AIRE AUT 700\*390\*16MM T/SOLDADO



|                                   |                 |
|-----------------------------------|-----------------|
| <b>CV</b>                         |                 |
| <b>MALIBU 2.4L/3.6L 2008-2012</b> |                 |
| CÓDIGO:                           | <b>CRNC3030</b> |
| EQUIV 1:                          | DPI-2864/36405  |
| EQUIV 2:                          |                 |
| OEM:                              | 52495681        |
|                                   |                 |

RADIADOR AGUA C/S AIRE AUT 700\*390\*20MM (G6 05-10) T/SOLDADO



|                              |                 |
|------------------------------|-----------------|
| <b>CV</b>                    |                 |
| <b>MALIBU 3.5L 2004-2007</b> |                 |
| CÓDIGO:                      | <b>CRNC3020</b> |
| EQUIV 1:                     | DPI-2727/35946  |
| EQUIV 2:                     |                 |
| OEM:                         | 52494386        |
|                              |                 |

RADIADOR AGUA C/S AIRE AUT 700\*390\*20MM (G6 05-10) T/SOLDADO



|                                |                 |
|--------------------------------|-----------------|
| <b>CV</b>                      |                 |
| <b>MATIZ G1 1.0L 2003-2005</b> |                 |
| CÓDIGO:                        | <b>CRNG0100</b> |
| EQUIV 1:                       | 35963           |
| EQUIV 2:                       |                 |
| OEM:                           | 96322941        |
|                                |                 |

RADIADOR AGUA S/AIRE STD 480\*330\*22MM T/MECANICO



|                                |                 |
|--------------------------------|-----------------|
| <b>CV</b>                      |                 |
| <b>MATIZ G2 1.0L 2006-2015</b> |                 |
| CÓDIGO:                        | <b>CRNG0110</b> |
| EQUIV 1:                       | 35931           |
| EQUIV 2:                       |                 |
| OEM:                           | 96591475        |
|                                |                 |

RADIADOR AGUA C/S AIRE STD 480\*350\*20MM T/MECANICO

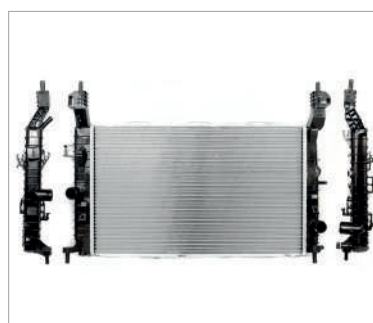

|                              |                 |
|------------------------------|-----------------|
| <b>CV</b>                    |                 |
| <b>MERIVA 1.8L 2004-2008</b> |                 |
| CÓDIGO:                      | <b>CRNC1600</b> |
| EQUIV 1:                     | 36090           |
| EQUIV 2:                     |                 |
| OEM:                         | 52400707        |
|                              |                 |

RADIADOR AGUA C/S AIRE STD 610\*370\*26MM T/SOLDADO



|                                 |                 |
|---------------------------------|-----------------|
| <b>CV</b>                       |                 |
| <b>ONIX 1.0L/1.2L 2020-2024</b> |                 |
| CÓDIGO:                         | <b>CRNC0500</b> |
| EQUIV 1:                        |                 |
| EQUIV 2:                        |                 |
| OEM:                            | 26287393        |
|                                 |                 |

RADIADOR AGUA C/S AIRE STD MM T/SOLDADO



|                                 |                 |
|---------------------------------|-----------------|
| <b>CV</b>                       |                 |
| <b>ONIX 1.0L/1.2L 2020-2024</b> |                 |
| CÓDIGO:                         | <b>CRNC0510</b> |
| EQUIV 1:                        |                 |
| EQUIV 2:                        |                 |
| OEM:                            | 26287385        |
|                                 |                 |

RADIADOR AGUA C/S AIRE AUT MM T/SOLDADO



|                             |                 |
|-----------------------------|-----------------|
| <b>CV</b>                   |                 |
| <b>OPTRA 2.0L 2006-2010</b> |                 |
| CÓDIGO:                     | <b>CRNC1700</b> |
| EQUIV 1:                    | DPI-2788MT      |
| EQUIV 2:                    |                 |
| OEM:                        | 96553423        |
|                             |                 |

RADIADOR AGUA C/S AIRE STD 710\*390\*16MM T/SOLDADO



|                             |                      |
|-----------------------------|----------------------|
| <b>CV</b>                   |                      |
| <b>OPTRA 2.0L 2006-2010</b> |                      |
| CÓDIGO:                     | <b>CRNC1710</b>      |
| EQUIV 1:                    | DPI-2788AT/36034     |
| EQUIV 2:                    |                      |
| OEM:                        | 96553243/17700-85Z01 |
|                             |                      |

RADIADOR AGUA C/S AIRE AUT 710\*390\*16MM (FORENZA 2.0L 04-08) T/SOLDADO



|                                     |                 |
|-------------------------------------|-----------------|
| <b>CV</b>                           |                 |
| <b>S-10 MAX 2.0L/2.4L 2022-2024</b> |                 |
| CÓDIGO:                             | <b>CRNC1800</b> |
| EQUIV 1:                            |                 |
| EQUIV 2:                            |                 |
| OEM:                                | 19436658        |
|                                     |                 |

RADIADOR AGUA C/S AIRE STD/AUT 000\*000\*00MM T/SOLDADO



|                                   |                   |
|-----------------------------------|-------------------|
| <b>CV</b>                         |                   |
| <b>S-10/BLAZER 4.3L 1995-2005</b> |                   |
| CÓDIGO:                           | <b>CRNC1810</b>   |
| EQUIV 1:                          | DPI-1825/35663    |
| EQUIV 2:                          |                   |
| OEM:                              | 52462549/52472964 |
|                                   |                   |

RADIA AGUA C/S AIRE STD 690\*410\*16MM C/HOYO P/ENFRIADOR ACE (JIMMY/SONOMA) T/SDO



|                                   |                 |
|-----------------------------------|-----------------|
| <b>CV</b>                         |                 |
| <b>S-10/BLAZER 4.3L 1995-2005</b> |                 |
| CÓDIGO:                           | <b>CRNC1826</b> |
| EQUIV 1:                          | DPI-1826/35755  |
| EQUIV 2:                          |                 |
| OEM:                              | 15120548        |
|                                   |                 |

RADIA AGUA C/S AIRE AUT 690\*410\*26MM P/2 ENFRIADOR ACEITE (SUBURBAN/JIMMY) T/SDO



|   |                   |
|---|-------------------|
| <b>CV</b>                                 |                   |
| <b>SILVERADO 1500 4.8L/5.3L 1999-2014</b> |                   |
| CÓDIGO:                                   | <b>CRNC2610</b>   |
| EQUIV 1:                                  | DPI-2334/36056    |
| EQUIV 2:                                  |                   |
| OEM:                                      | 52486598/15193110 |
|   |                   |

RADIADOR AGUA C/S AIRE AUT 740\*470\*26MM (2500) S/HOYO P/ENFRIADOR ACEITE T/SDO



|                                      |                 |
|--------------------------------------|-----------------|
| <b>CV</b>                            |                 |
| <b>SILVERADO 4.8L/5.3L 1999-2010</b> |                 |
| CÓDIGO:                              | <b>CRNC2600</b> |
| EQUIV 1:                             | DPI-2370/35749  |
| EQUIV 2:                             |                 |
| OEM:                                 | 15841570        |
|                                      |                 |

RADIADOR AGUA C/S AIRE AUT 880\*470\*26MM 4ENTRAS P/ACEITE (SUBURBAN) T/SOLDADO



|                                      |                 |
|--------------------------------------|-----------------|
| <b>CV</b>                            |                 |
| <b>SILVERADO 4.8L/5.3L 1999-2010</b> |                 |
| CÓDIGO:                              | <b>CRNC2620</b> |
| EQUIV 1:                             | DPI-2423/35748  |
| EQUIV 2:                             |                 |
| OEM:                                 | 15193108        |
|                                      |                 |

RADIADOR AGUA C/S AIRE AUT 880\*470\*26MM 2ENTRAS P/ACEITE (SIERRA) T/SOLDADO

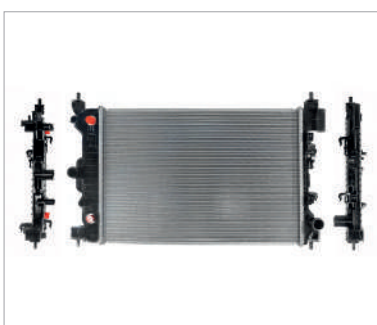

|                             |                 |
|-----------------------------|-----------------|
| <b>CV</b>                   |                 |
| <b>SONIC 1.6L 2012-2012</b> |                 |
| CÓDIGO:                     | <b>CRNC0900</b> |
| EQUIV 1:                    | 36195U          |
| EQUIV 2:                    |                 |
| OEM:                        | 95460096        |
|                             |                 |

RADIADOR AGUA C/S AIRE AUT 580\*390\*16MM T/SOLDADO

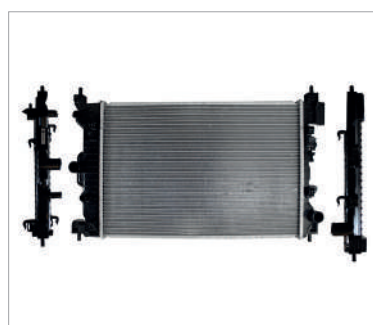

|                             |                 |
|-----------------------------|-----------------|
| <b>CV</b>                   |                 |
| <b>SONIC 1.6L 2012-2012</b> |                 |
| CÓDIGO:                     | <b>CRNC0910</b> |
| EQUIV 1:                    | 36195           |
| EQUIV 2:                    |                 |
| OEM:                        | 95316030        |
|                             |                 |

RADIADOR AGUA C/S AIRE STD 580\*390\*16MM T/SOLDADO

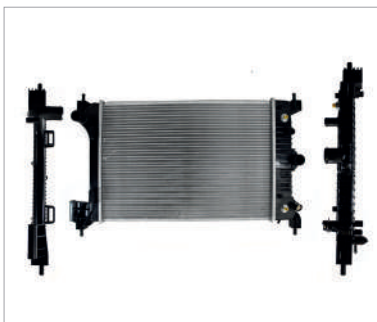

|                             |                 |
|-----------------------------|-----------------|
| <b>CV</b>                   |                 |
| <b>SONIC 1.6L 2013-2018</b> |                 |
| CÓDIGO:                     | <b>CRNC0920</b> |
| EQUIV 1:                    | DPI-13247/36194 |
| EQUIV 2:                    |                 |
| OEM:                        | 95316047        |
|                             |                 |

RADIADOR AGUA C/S AIRE STD/AUT 550\*370\*16MM (TRAX 1.8L 13-20) T/ SOLDADO

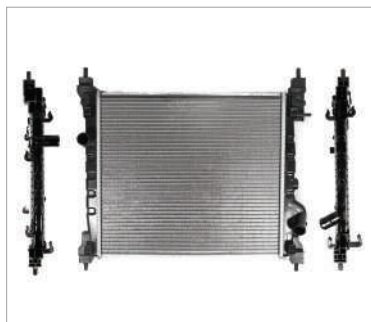

|                             |                 |
|-----------------------------|-----------------|
| <b>CV</b>                   |                 |
| <b>SPARK 1.2L 2011-2017</b> |                 |
| CÓDIGO:                     | <b>CRNC0810</b> |
| EQUIV 1:                    | DPI-13342/36176 |
| EQUIV 2:                    |                 |
| OEM:                        | 96676341        |
|                             |                 |

RADIADOR AGUA C/S AIRE STD 450\*390\*16MM T/SOLDADO (BEAT 1.2L 18-21)

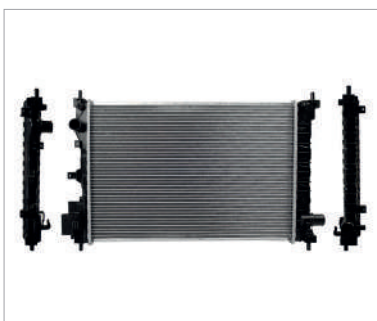

|                                |                 |
|--------------------------------|-----------------|
| <b>CV</b>                      |                 |
| <b>SPARK NG 1.4L 2016-2021</b> |                 |
| CÓDIGO:                        | <b>CRNC0800</b> |
| EQUIV 1:                       | DPI-13590       |
| EQUIV 2:                       |                 |
| OEM:                           | 42349017        |
|                                |                 |

RADIADOR AGUA C/S AIRE STD 610\*400\*16MM T/SOLDADO (NUEVA LI-NEA)



|                                |                 |
|--------------------------------|-----------------|
| <b>CV</b>                      |                 |
| <b>SPARK NG 1.4L 2016-2021</b> |                 |
| CÓDIGO:                        | <b>CRNC0820</b> |
| EQUIV 1:                       | DPI-13646       |
| EQUIV 2:                       |                 |
| OEM:                           | 42349018        |
|                                |                 |

RADIADOR AGUA C/S AIRE AUT 610\*400\*16MM T/SOLDADO (NUEVA LI-NEA)



|                                    |                     |
|------------------------------------|---------------------|
| <b>CV</b>                          |                     |
| <b>TRACKER 2.2L/2.5L 1999-2008</b> |                     |
| CÓDIGO:                            | <b>CRNC1900</b>     |
| EQUIV 1:                           | DPI-2087/35836      |
| EQUIV 2:                           |                     |
| OEM:                               | 1770077E10/1770077E |
|                                    |                     |

RADIADOR AGUA C/S AIRE AUT 550\*440\*26MM (GRAND VITARA 2.5L 99-05) T/SOLDADO

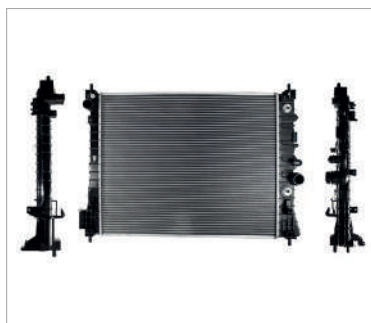

|                            |                 |
|----------------------------|-----------------|
| <b>CV</b>                  |                 |
| <b>TRAX 1.4L 2013-2020</b> |                 |
| CÓDIGO:                    | <b>CRNC0700</b> |
| EQUIV 1:                   | DPI-13361/36239 |
| EQUIV 2:                   |                 |
| OEM:                       | 95298552        |
|                            |                 |

RADIADOR AGUA C/S AIRE AUT 620\*500\*26MM (ENCORE 1.4L 14-21) T/ SOLDADO



|                                     |                   |
|-------------------------------------|-------------------|
| <b>CV</b>                           |                   |
| <b>UPLANDER 3.4L/3.5L 2001-2007</b> |                   |
| CÓDIGO:                             | <b>CRNC6900</b>   |
| EQUIV 1:                            | DPI-2562/35878    |
| EQUIV 2:                            |                   |
| OEM:                                | 10312317/10310318 |
|                                     |                   |

RADIADOR AGUA C/S AIRE AUT 790\*380\*20MM (VENTURE 01-07/AZTEK 01-07) T/SOLDADO



|                                |                   |
|--------------------------------|-------------------|
| <b>CV</b>                      |                   |
| <b>UPLANDER 3.9L 2007-2009</b> |                   |
| CÓDIGO:                        | <b>CRNC6910</b>   |
| EQUIV 1:                       | DPI-2881/36109    |
| EQUIV 2:                       |                   |
| OEM:                           | 15211586/15892121 |
|                                |                   |

RADIADOR AGUA C/S AIRE AUT 790\*380\*20MM (MONTANA 3.9L 05-09) T/ SOLDADO



|                            |                 |
|----------------------------|-----------------|
| <b>DG</b>                  |                 |
| <b>ATOS 1.0L 2000-2004</b> |                 |
| CÓDIGO:                    | <b>CRNK0100</b> |
| EQUIV 1:                   | 35690           |
| EQUIV 2:                   |                 |
| OEM:                       | 25310-02100     |
|                            |                 |

RADIADOR AGUA S/AIRE STD 380\*370\*22MM T/MECANICO

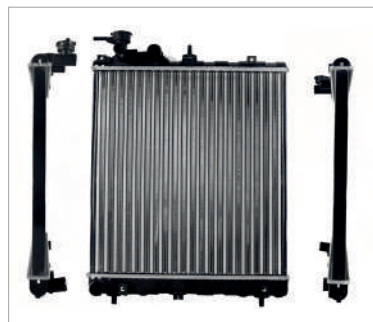

|                            |                 |
|----------------------------|-----------------|
| <b>DG</b>                  |                 |
| <b>ATOS 1.1L 2005-2012</b> |                 |
| CÓDIGO:                    | <b>CRNK0110</b> |
| EQUIV 1:                   | 35691           |
| EQUIV 2:                   |                 |
| OEM:                       | 25310-07000     |
|                            |                 |

RADIADOR AGUA S/AIRE STD 400\*430\*22MM T/MECANICO



|                                |                 |
|--------------------------------|-----------------|
| <b>DG</b>                      |                 |
| <b>ATTITUDE 1.2L 2015-2024</b> |                 |
| CÓDIGO:                        | <b>CRNK1110</b> |
| EQUIV 1:                       |                 |
| EQUIV 2:                       |                 |
| OEM:                           | 1350A801        |
|                                |                 |

RADIADOR AGUA C/S AIRE STD 390\*370\*16MM (MT G4 19-24/MIRAGE 15-16) T/SOLDADO



|                                |                 |
|--------------------------------|-----------------|
| <b>DG</b>                      |                 |
| <b>ATTITUDE 1.2L 2015-2024</b> |                 |
| CÓDIGO:                        | <b>CRNK1160</b> |
| EQUIV 1:                       | DPI-13469/36254 |
| EQUIV 2:                       |                 |
| OEM:                           | 1350A670        |
|                                |                 |

RADIADOR AGUA C/S AIRE AUT 480\*380\*16MM (MT G4 19-24/MIRAGE 15-16) T/SOLDADO

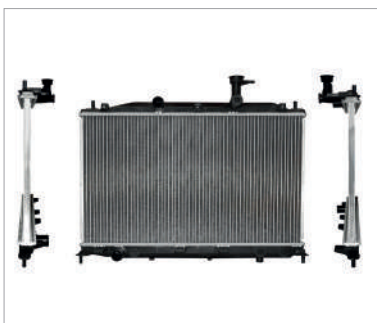

|                                     |                 |
|-------------------------------------|-----------------|
| <b>DG</b>                           |                 |
| <b>ATTITUDE 1.4L/1.6L 2006-2011</b> |                 |
| CÓDIGO:                             | <b>CRNK1100</b> |
| EQUIV 1:                            | DPI-2904/36000  |
| EQUIV 2:                            |                 |
| OEM:                                | 25310-1E000     |
|                                     |                 |

RADIADOR AGUA C/S AIRE STD 660\*390\*16MM T/SOLDADO



|                                     |                 |
|-------------------------------------|-----------------|
| <b>DG</b>                           |                 |
| <b>ATTITUDE 1.4L/1.6L 2006-2011</b> |                 |
| CÓDIGO:                             | <b>CRNK1150</b> |
| EQUIV 1:                            | DPI-2896        |
| EQUIV 2:                            |                 |
| OEM:                                | 25310-1E151     |
|                                     |                 |

RADIADOR AGUA C/S AIRE AUT 660\*390\*16MM T/SOLDADO

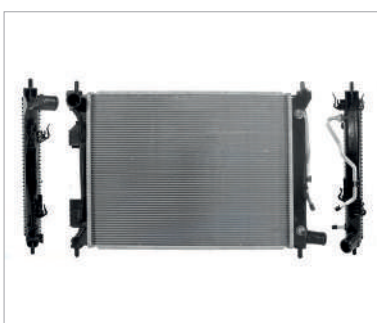

|                                |                 |
|--------------------------------|-----------------|
| <b>DG</b>                      |                 |
| <b>ATTITUDE 1.6L 2012-2014</b> |                 |
| CÓDIGO:                        | <b>CRNK1170</b> |
| EQUIV 1:                       | DPI-13253       |
| EQUIV 2:                       |                 |
| OEM:                           | 25310-1R050     |
|                                |                 |

RADIA AGUA C/S AIRE AUT 520\*400\*16MM (GRAND I-10 1.2L 15-20/RIO 1.6L 16-17) T/S



|                                    |                     |
|------------------------------------|---------------------|
| <b>DG</b>                          |                     |
| <b>AVENGER 2.4L/3.5L 2007-2014</b> |                     |
| CÓDIGO:                            | <b>CRNK0900</b>     |
| EQUIV 1:                           | DPI-2950-2951/35929 |
| EQUIV 2:                           |                     |
| OEM:                               | 68004049AA          |
|                                    |                     |

RADIADOR AGUA C/S AIRE AUT 720\*420\*20MM (PATRIOT/CALIBER/COMPASS/CIRRUS) T/SDO





|   |                 |
|---|-----------------|
| <b>DG</b>                               |                 |
| <b>CARAVAN 2.4L/3.3L/3.8L 1996-2000</b> |                 |
| CÓDIGO:                                 | <b>CRNK0710</b> |
| EQUIV 1:                                | DPI-1850/35693  |
| EQUIV 2:                                |                 |
| OEM:                                    | 4682976AB       |
|   |                 |

RADIADOR AGUA C/S AIRE AUT 680\*400\*32MM (VOYAGER) TOMAS EN LINEA T/SOLDADO



|   |                 |
|---|-----------------|
| <b>DG</b>                               |                 |
| <b>CARAVAN 2.4L/3.3L/3.8L 1996-2000</b> |                 |
| CÓDIGO:                                 | <b>CRNK0720</b> |
| EQUIV 1:                                | DPI-1862/35694  |
| EQUIV 2:                                |                 |
| OEM:                                    | 4682976AC       |
|   |                 |

RADIADOR AGUA C/S AIRE AUT 680\*400\*32MM (VOYAGER) TOMAS CRUZADAS T/SOLDADO



|                                    |                 |
|------------------------------------|-----------------|
| <b>DG</b>                          |                 |
| <b>CARAVAN 3.3L/3.8L 2001-2004</b> |                 |
| CÓDIGO:                            | <b>CRNK0730</b> |
| EQUIV 1:                           | DPI-2311/35551  |
| EQUIV 2:                           |                 |
| OEM:                               | 4809225AE       |
|                                    |                 |

RADIADOR AGUA C/S AIRE AUT 790\*440\*32MM (VOYAGER/T&COUNTRY) T/SOLDADO



|                                    |                 |
|------------------------------------|-----------------|
| <b>DG</b>                          |                 |
| <b>CARAVAN 3.3L/3.8L 2005-2007</b> |                 |
| CÓDIGO:                            | <b>CRNK0740</b> |
| EQUIV 1:                           | DPI-2795/35920  |
| EQUIV 2:                           |                 |
| OEM:                               | 4677523AA       |
|                                    |                 |

RADIADOR AGUA C/S AIRE AUT 790\*440\*32MM (VOYAGER/T&COUNTRY) T/SOLDADO



|                               |                 |
|-------------------------------|-----------------|
| <b>DG</b>                     |                 |
| <b>CHARGER 6.1L 2006-2010</b> |                 |
| CÓDIGO:                       | <b>CRNK9000</b> |
| EQUIV 1:                      | DPI-2767/35956  |
| EQUIV 2:                      |                 |
| OEM:                          | 5137691AA       |
|                               |                 |

RADIADOR AGUA C/S AIRE AUT 640\*490\*32MM (300 SRT 06-08/CHALLENGER 08) T/SOLDADO



|   |                     |
|---|---------------------|
| <b>DG</b>                                   |                     |
| <b>DAKOTA 2.5L/3.7L/3.9L/5.9L 2000-2004</b> |                     |
| CÓDIGO:                                     | <b>CRNK4110</b>     |
| EQUIV 1:                                    | DPI-2294/35697      |
| EQUIV 2:                                    |                     |
| OEM:  | 52028816AC/52028816 |
|   |                     |

RADIADOR AGUA C/S AIRE AUT 620\*500\*32MM (DURANGO 00-03) T/SOLDADO



|                                   |                 |
|-----------------------------------|-----------------|
| <b>DG</b>                         |                 |
| <b>DAKOTA 3.7L/4.7L 2005-2012</b> |                 |
| CÓDIGO:                           | <b>CRNK4120</b> |
| EQUIV 1:                          | DPI-2883/35965  |
| EQUIV 2:                          |                 |
| OEM:                              | 55056506AD      |
|                                   |                 |

RADIADOR AGUA C/S AIRE AUT 580\*470\*26MM (MT RAIDER 06-09) T/SOLDADO



|  |                   |
|--|-------------------|
| <b>DG</b>                              |                   |
| <b>DAKOTA 3.7L/5.2L/5.9L 1997-2000</b> |                   |
| CÓDIGO:                                | <b>CRNK4100</b>   |
| EQUIV 1:                               | DPI-1905/35692    |
| EQUIV 2:                               |                   |
| OEM:                                   | 52028775/52029146 |
|  |                   |

RADIADOR AGUA C/S AIRE AUT 580\*590\*32MM (DURANGO 98-00) T/SOLDADO



|                                    |                       |
|------------------------------------|-----------------------|
| <b>DG</b>                          |                       |
| <b>DURANGO 3.6L/5.7L 2011-2020</b> |                       |
| CÓDIGO:                            | <b>CRNK2310</b>       |
| EQUIV 1:                           | DPI-13204-13200/36182 |
| EQUIV 2:                           |                       |
| OEM:                               | 55038001AG/55038001   |
|                                    |                       |

RADIADOR AGUA C/S AIRE AUT 660\*520\*26MM (GRAND CHEROKEE 3.6L 11-20) T/SOLDADO



|   |                 |
|---|-----------------|
| <b>DG</b>                                 |                 |
| <b>G.CARAVAN 3.3L/3.6L/4.0L 2008-2018</b> |                 |
| CÓDIGO:                                   | <b>CRNK0700</b> |
| EQUIV 1:                                  | DPI-13063/35978 |
| EQUIV 2:                                  |                 |
| OEM:                                      | 4677755A        |
|   |                 |

RADIADOR AGUA C/S AIRE AUT 610\*520\*32MM (VW ROUTAN 3.6L) T/ SOLDADO



|  |                 |
|--|-----------------|
| <b>DG</b>                                  |                 |
| <b>G.CHEROKEE 3.7L/4.7L/5.7L 2005-2010</b> |                 |
| CÓDIGO:                                    | <b>CRNK1340</b> |
| EQUIV 1:                                   | DPI-2839/36002  |
| EQUIV 2:                                   |                 |
| OEM:                                       | 55116849AB      |
|  |                 |

RADIADOR AGUA C/S AIRE AUT 610\*540\*32MM (COMANDER 06-10) T/ SOLDADO



|                                      |                     |
|--------------------------------------|---------------------|
| <b>DG</b>                            |                     |
| <b>GRAND CHEROKEE 4.0L 1999-2004</b> |                     |
| CÓDIGO:                              | <b>CRNK1310</b>     |
| EQUIV 1:                             | DPI-2262/35585      |
| EQUIV 2:                             |                     |
| OEM:                                 | 52079428/52079428AB |
|                                      |                     |

RADIADOR AGUA C/S AIRE AUT 620\*580\*26MM T/SOLDADO



|                                      |                     |
|--------------------------------------|---------------------|
| <b>DG</b>                            |                     |
| <b>GRAND CHEROKEE 4.7L 1999-2000</b> |                     |
| CÓDIGO:                              | <b>CRNK1320</b>     |
| EQUIV 1:                             | DPI-2263/35587      |
| EQUIV 2:                             |                     |
| OEM:                                 | 52079425/52079425AB |
|                                      |                     |

RADIADOR AGUA C/S AIRE AUT 620\*580\*20MM T/SOLDADO



|                                      |                     |
|--------------------------------------|---------------------|
| <b>DG</b>                            |                     |
| <b>GRAND CHEROKEE 4.7L 2001-2004</b> |                     |
| CÓDIGO:                              | <b>CRNK1330</b>     |
| EQUIV 1:                             | DPI-2336/35581      |
| EQUIV 2:                             |                     |
| OEM:                                 | 52079883/52079883AB |
|                                      |                     |

RADIADOR AGUA C/S AIRE AUT 610\*540\*26MM T/SOLDADO



|                                    |                 |
|------------------------------------|-----------------|
| <b>DG</b>                          |                 |
| <b>H-100 2.5L DIESEL 2006-2012</b> |                 |
| CÓDIGO:                            | <b>CRNK1410</b> |
| EQUIV 1:                           | 36080           |
| EQUIV 2:                           |                 |
| OEM:                               | 25310-4F210     |
|                                    |                 |

RADIADOR AGUA C/S AIRE STD 580\*460\*26MM T/SOLDADO



|                            |                 |
|----------------------------|-----------------|
| <b>DG</b>                  |                 |
| <b>I-10 1.1L 2011-2014</b> |                 |
| CÓDIGO:                    | <b>CRNK0800</b> |
| EQUIV 1:                   | 36175           |
| EQUIV 2:                   |                 |
| OEM:                       | 25310-0X100     |
|                            |                 |

RADIADOR AGUA C/S AIRE STD 450\*370\*16MM T/SOLDADO



|                                    |                     |
|------------------------------------|---------------------|
| <b>DG</b>                          |                     |
| <b>JOURNEY 2.4L/3.6L 2009-2020</b> |                     |
| CÓDIGO:                            | <b>CRNK8100</b>     |
| EQUIV 1:                           | DPI-13084/35995     |
| EQUIV 2:                           |                     |
| OEM:                               | 68038238/68038238AA |
|                                    |                     |

RADIADOR AGUA C/S AIRE AUT 660\*470\*16MM T/SOLDADO



|                               |                 |
|-------------------------------|-----------------|
| <b>DG</b>                     |                 |
| <b>LIBERTY 3.7L 2002-2007</b> |                 |
| CÓDIGO:                       | <b>CRNK3600</b> |
| EQUIV 1:                      | DPI-2481/35533  |
| EQUIV 2:                      |                 |
| OEM:                          | 52080118AB      |
|                               |                 |

RADIADOR AGUA C/S AIRE AUT 530\*530\*26MM T/SOLDADO



|                            |                 |
|----------------------------|-----------------|
| <b>DG</b>                  |                 |
| <b>NEON 2.0L 1995-2000</b> |                 |
| CÓDIGO:                    | <b>CRNK0220</b> |
| EQUIV 1:                   | DPI-2196/35530  |
| EQUIV 2:                   |                 |
| OEM:                       | 4546902         |
|                            |                 |

RADIADOR AGUA C/S AIRE AUT 660\*310\*20MM TIPO NACIONAL T/SOLDADO



|                                |                 |
|--------------------------------|-----------------|
| <b>DG</b>                      |                 |
| <b>NEON 2.0L USA 1995-2000</b> |                 |
| CÓDIGO:                        | <b>CRNK0200</b> |
| EQUIV 1:                       | DPI-1548/35669  |
| EQUIV 2:                       |                 |
| OEM:                           | 4740097/4495947 |
|                                |                 |

RADIADOR AGUA C/S AIRE AUT 620\*320\*16MM T/SOLDADO



|                                  |                 |
|----------------------------------|-----------------|
| <b>DG</b>                        |                 |
| <b>NITRO 3.7L/4.0L 2007-2012</b> |                 |
| CÓDIGO:                          | <b>CRNK1600</b> |
| EQUIV 1:                         | DPI-2971/35966  |
| EQUIV 2:                         |                 |
| OEM:                             | 68003973AB      |
|                                  |                 |

RADIADOR AGUA C/S AIRE AUT 620\*520\*26MM (LIBERTY 3.7L 08-13) T/SOLDADO



|                                  |                   |
|----------------------------------|-------------------|
| <b>DG</b>                        |                   |
| <b>PT-CRUISER 2.4L 2001-2010</b> |                   |
| CÓDIGO:                          | <b>CRNK4500</b>   |
| EQUIV 1:                         | DPI-2298/35834    |
| EQUIV 2:                         |                   |
| OEM:                             | 5017404/5017404AA |
|                                  |                   |

RADIADOR AGUA C/S AIRE AUT 530\*480\*26MM T/SOLDADO



|  |                     |
|--|---------------------|
| <b>DG</b>                              |                     |
| <b>PT-CRUISER 2.4L TURBO 2003-2008</b> |                     |
| CÓDIGO:                                | <b>CRNK4510</b>     |
| EQUIV 1:                               | DPI-2677            |
| EQUIV 2:                               |                     |
| OEM:                                   | 5096190AB/5098296AA |
|  |                     |

RADIADOR AGUA C/S AIRE AUT 530\*480\*26MM T/SOLDADO



|                                     |                     |
|-------------------------------------|---------------------|
| <b>DG</b>                           |                     |
| <b>RAM 1500 3.7L/4.7L 2002-2013</b> |                     |
| CÓDIGO:                             | <b>CRNK0340</b>     |
| EQUIV 1:                            | DPI-2479/35774STD   |
| EQUIV 2:                            |                     |
| OEM:                                | 52030191AB/52028829 |
|                                     |                     |

RADIADOR AGUA C/S AIRE STD 640\*480\*32MM T/SOLDADO



|                                     |                     |
|-------------------------------------|---------------------|
| <b>DG</b>                           |                     |
| <b>RAM 1500 3.7L/4.7L 2002-2013</b> |                     |
| CÓDIGO:                             | <b>CRNK0350</b>     |
| EQUIV 1:                            | DPI-2480/35862      |
| EQUIV 2:                            |                     |
| OEM:                                | 52028830AE/52028830 |
|                                     |                     |

RADIADOR AGUA C/S AIRE AUT 640\*480\*32MM (RAM 2500 5.7L-5.9L 94-02) T/SOLDADO



|                                |                   |
|--------------------------------|-------------------|
| <b>DG</b>                      |                   |
| <b>RAM 1500 3.9L 1994-2001</b> |                   |
| CÓDIGO:                        | <b>CRNK0300</b>   |
| EQUIV 1:                       | DPI-1552/35502    |
| EQUIV 2:                       |                   |
| OEM:                           | 52006491/52028057 |
|                                |                   |

RADIADOR AGUA C/S AIRE AUT 820\*510\*32MM (RAM 2500 5.2L 94-02) T/SOLDADO



|   |                     |
|---|---------------------|
| <b>DG</b>                                 |                     |
| <b>RAM 1500 VAN 3.9L DIESEL 1994-2003</b> |                     |
| CÓDIGO:                                   | <b>CRNK0330</b>     |
| EQUIV 1:                                  | DPI-1707/36099      |
| EQUIV 2:                                  |                     |
| OEM:                                      | 52028627AB/52029115 |
|   |                     |

RADIADOR AGUA C/S AIRE AUT 700\*490\*32MM (RAM 2500-3500 VAN 5.9L DIESEL) T/SDO



|                                       |                 |
|---------------------------------------|-----------------|
| <b>DG</b>                             |                 |
| <b>RAM 2500 5.9L DIESEL 2003-2008</b> |                 |
| CÓDIGO:                               | <b>CRNK0360</b> |
| EQUIV 1:                              | DPI-2711/36027  |
| EQUIV 2:                              |                 |
| OEM:                                  | 55037652        |
|                                       |                 |

RADIADOR AGUA C/S AIRE AUT 700\*740\*32MM (RAM 4000 6.7L DIESEL 03-08) T/SOLDADO



|                                     |                 |
|-------------------------------------|-----------------|
| <b>DG</b>                           |                 |
| <b>RAM 2500/3500 5.9L 1994-2003</b> |                 |
| CÓDIGO:                             | <b>CRNK0310</b> |
| EQUIV 1:                            | DPI-2291/36021  |
| EQUIV 2:                            |                 |
| OEM:                                | 52029176AA      |
|                                     |                 |

RADIADOR AGUA C/S AIRE AUT 820\*510\*32MM (RAM 4000 5.9L 94-02) T/SOLDADO



|  |                   |
|--|-------------------|
| <b>DG</b>                                  |                   |
| <b>RAM 2500/3500 5.9L DIESEL 1994-2003</b> |                   |
| CÓDIGO:                                    | <b>CRNK0320</b>   |
| EQUIV 1:                                   | DPI-1553/36098    |
| EQUIV 2:                                   |                   |
| OEM:                                       | 52006479/52030191 |
|  |                   |

RADIADOR AGUA C/S AIRE STD 940\*500\*57MM T/SOLDADO

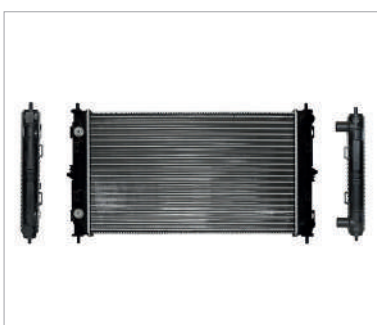

|   |                 |
|---|-----------------|
| <b>DG</b>                               |                 |
| <b>STRATUS 2.0L/2.4L/2.5L 1995-2000</b> |                 |
| CÓDIGO:                                 | <b>CRNK0400</b> |
| EQUIV 1:                                | DPI-1702/35580  |
| EQUIV 2:                                |                 |
| OEM:                                    | 4596399AA       |
|   |                 |

RADIADOR AGUA C/S AIRE STD/AUT 640\*380\*32MM (CIRRUS 2.0L-2.4L-2.5L) T/MECANICO



|   |                 |
|---|-----------------|
| <b>DG</b>                               |                 |
| <b>STRATUS 2.0L/2.4L/3.0L 2001-2006</b> |                 |
| CÓDIGO:                                 | <b>CRNK0420</b> |
| EQUIV 1:                                | DPI-2438/35915  |
| EQUIV 2:                                |                 |
| OEM:                                    | MB373103        |
|   |                 |

RADIADOR AGUA C/S AIRE AUT 720\*350\*26MM (SEBRING/ECLIPSE) T/SOLDADO



**DG**

## STRATUS 2.4L/3.0L 2001-2006

|          |                 |
|----------|-----------------|
| CÓDIGO:  | <b>CRNK0410</b> |
| EQUIV 1: | DPI-2323/35655  |
| EQUIV 2: |                 |
| OEM:     | 5017620/4773642 |



RADIADOR AGUA C/S AIRE STD 700\*400\*32MM (STRATUS RT 2.4L-3.0L/ CIRRUS) T/SOLDADO



**DG**

## VERNA 1.6L 2004-2006

|          |                     |
|----------|---------------------|
| CÓDIGO:  | <b>CRNK2500</b>     |
| EQUIV 1: | DPI-2338/36001      |
| EQUIV 2: |                     |
| OEM:     | 2531025150/25310250 |



RADIADOR AGUA C/S AIRE AUT 660\*360\*16MM T/SOLDADO



**FD**

## ESCAPE 2.3L 2001-2007

|          |                       |
|----------|-----------------------|
| CÓDIGO:  | <b>CRNF0510</b>       |
| EQUIV 1: | DPI-2306/35633        |
| EQUIV 2: |                       |
| OEM:     | YL8H-8005KB/YF1015200 |



RADIADOR AGUA C/S AIRE AUT 720\*490\*26MM T/SOLDADO



**FD**

## ESCAPE 2.5L 2008-2012

|          |                       |
|----------|-----------------------|
| CÓDIGO:  | <b>CRNF0520</b>       |
| EQUIV 1: | DPI-13040-13060/36162 |
| EQUIV 2: |                       |
| OEM:     | 8L8Z-8005A/9L8Z-8005A |



RADIADOR AGUA C/S AIRE AUT 720\*460\*20MM T/SOLDADO



**FD**

## ESCAPE 2.5L 2013-2019

|          |                 |
|----------|-----------------|
| CÓDIGO:  | <b>CRNF0540</b> |
| EQUIV 1: | DPI-13313/36190 |
| EQUIV 2: |                 |
| OEM:     | CV6Z-8005B      |



RADIADOR AGUA C/S AIRE AUT 690\*470\*26MM (TRANSIT 2.5L 14-20) T/ SOLDADO



**FD**

## ESCAPE 3.0L 2001-2007

|          |                       |
|----------|-----------------------|
| CÓDIGO:  | <b>CRNF0500</b>       |
| EQUIV 1: | DPI-2307/35632        |
| EQUIV 2: |                       |
| OEM:     | YL8H-8005LB/AJ0315200 |



RADIADOR AGUA C/S AIRE AUT 720\*460\*26MM (MARINER 3.0L 05-07) T/ SOLDADO



**FD**

## ESCAPE 3.0L 2008-2012

|          |                 |
|----------|-----------------|
| CÓDIGO:  | <b>CRNF0530</b> |
| EQUIV 1: | DPI-13041/36228 |
| EQUIV 2: |                 |
| OEM:     | 8L8Z-8005B      |



RADIADOR AGUA C/S AIRE AUT 720\*460\*26MM T/SOLDADO



**FD**

## EXPEDITION 4.6L/5.4L 2003-2006

|          |                         |
|----------|-------------------------|
| CÓDIGO:  | <b>CRNF2900</b>         |
| EQUIV 1: | DPI-2609/36020          |
| EQUIV 2: |                         |
| OEM:     | 2L1H-8009DF/2L1Z-8005DD |



RADIADOR AGUA C/S AIRE AUT 710\*520\*44MM (NAVIGATOR) T/SOLDADO



|                                  |                 |
|----------------------------------|-----------------|
| <b>FD</b>                        |                 |
| <b>EXPEDITION 5.4L 2007-2010</b> |                 |
| CÓDIGO:                          | <b>CRNF2910</b> |
| EQUIV 1:                         | DPI-13045/36124 |
| EQUIV 2:                         |                 |
| OEM:                             | 7L1Z-8005B      |
|                                  |                 |

RADIADOR AGUA C/S AIRE AUT V8 820\*450\*32MM (NAVIGATOR 07-11) T/SOLDADO



|                                     |                         |
|-------------------------------------|-------------------------|
| <b>FD</b>                           |                         |
| <b>EXPLORER 4.0L/4.6L 2001-2005</b> |                         |
| CÓDIGO:                             | <b>CRNF2510</b>         |
| EQUIV 1:                            | DPI-2342/35852          |
| EQUIV 2:                            |                         |
| OEM:                                | 1L2H-8005DC/1L2Z-8005DC |
|                                     |                         |

RADIADOR AGUA C/S AIRE AUT 640\*560\*32MM (MOUNTAINEER) T/SOLDADO



|                                     |                         |
|-------------------------------------|-------------------------|
| <b>FD</b>                           |                         |
| <b>EXPLORER 4.0L/4.6L 2006-2010</b> |                         |
| CÓDIGO:                             | <b>CRNF2520</b>         |
| EQUIV 1:                            | DPI-2816/35927          |
| EQUIV 2:                            |                         |
| OEM:                                | 6L24-8005AB/6L2Z-8005AA |
|                                     |                         |

RADIADOR AGUA C/S AIRE AUT 580\*620\*32MM (EXPLORER SPORT TRAC) T/SOLDADO



|   |                 |
|---|-----------------|
| <b>FD</b>                               |                 |
| <b>F SERIES P/U 6.8L/7.3L 1999-2005</b> |                 |
| CÓDIGO:                                 | <b>CRNF2170</b> |
| EQUIV 1:                                | DPI-2170/35672  |
| EQUIV 2:                                |                 |
| OEM:                                    | 3C3Z-8005FA     |
|   |                 |

RADIADOR AGUA C/S AIRE AUT 770\*700\*26MM (EXCURSION) T/SOLDADO



|   |                 |
|---|-----------------|
| <b>FD</b>                               |                 |
| <b>F SERIES P/U 6.8L/7.3L 1999-2005</b> |                 |
| CÓDIGO:                                 | <b>CRNF2171</b> |
| EQUIV 1:                                | DPI-2171/35672  |
| EQUIV 2:                                |                 |
| OEM:                                    | 4C3Z-8005EB     |
|   |                 |

RADIADOR AGUA C/S AIRE AUT 770\*700\*57MM (EXCURSION) T/SOLDADO



|                             |                 |
|-----------------------------|-----------------|
| <b>FD</b>                   |                 |
| <b>F-150 3.7L 2009-2014</b> |                 |
| CÓDIGO:                     | <b>CRNF1870</b> |
| EQUIV 1:                    | DPI-13225/13226 |
| EQUIV 2:                    |                 |
| OEM:                        | BL3Z-8005A      |
|                             |                 |

RADIADOR AGUA C/S AIRE AUT 820\*450\*32MM (LOBO 5.0L 11-14) T/SOLDADO



|  |                 |
|--|-----------------|
| <b>FD</b>                                |                 |
| <b>F-150 4.2L/4.6L/5.4L V6 2004-2008</b> |                 |
| CÓDIGO:                                  | <b>CRNF1850</b> |
| EQUIV 1:                                 | DPI-2818/36461  |
| EQUIV 2:                                 |                 |
| OEM:                                     | 5L3Z-8005AA/CA  |
|  |                 |

RADIADOR AGUA C/S AIRE AUT 830\*440\*26MM (EXPEDIT 03-14/NAVIGA 5.4L 03-06) T/SDO



|                             |                 |
|-----------------------------|-----------------|
| <b>FD</b>                   |                 |
| <b>F-150 6.2L 2011-2014</b> |                 |
| CÓDIGO:                     | <b>CRNF1820</b> |
| EQUIV 1:                    | DPI-13227/36154 |
| EQUIV 2:                    |                 |
| OEM:                        | BL3Z-8005D      |
|                             |                 |

RADIADOR AGUA C/S AIRE AUT 820\*440\*32MM (EXPEDITION 11-14/LOBO 09-13) T/SOLDADO



|                                   |                    |
|-----------------------------------|--------------------|
| <b>FD</b>                         |                    |
| <b>F-150/F-250 4.2L 1997-1998</b> |                    |
| CÓDIGO:                           | <b>CRNF1830</b>    |
| EQUIV 1:                          | DPI-2141/35562     |
| EQUIV 2:                          |                    |
| OEM:                              | F75H-8005DB/F65HBA |
|                                   |                    |

RADIADOR AGUA C/S AIRE AUT 830\*430\*26MM (EXPEDITION 4.2L/LOBO 5.4L 01-02) T/SDO



|   |                         |
|---|-------------------------|
| <b>FD</b>                                   |                         |
| <b>F-150/F-250 4.6L/5.4L/6.0L 1997-2003</b> |                         |
| CÓDIGO:                                     | <b>CRNF1840</b>         |
| EQUIV 1:                                    | DPI-2136/35569          |
| EQUIV 2:                                    |                         |
| OEM:  | F75H-8005GA/F75H-8005GB |
|   |                         |

RADIADOR AGUA C/S AIRE AUT 840\*430\*57MM (F-350/EXPEDIT 05-06/ NAVIGA 97-02) T/SDO



|   |                 |
|---|-----------------|
| <b>FD</b>                                   |                 |
| <b>F-150/F-350/F450 4.6L/5.4L 2009-2014</b> |                 |
| CÓDIGO:                                     | <b>CRNF1860</b> |
| EQUIV 1:                                    | DPI-13099/36154 |
| EQUIV 2:                                    |                 |
| OEM:  | 9L3Z-8005B      |
|   |                 |

RADIADOR AGUA C/S AIRE AUT 820\*450\*32MM V8 (EXPEDITION 07-14) T/ SOLDADO



|   |                       |
|---|-----------------------|
| <b>FD</b>                                   |                       |
| <b>F-250 5.4L/6.2L SUPER DUTY 2008-2017</b> |                       |
| CÓDIGO:                                     | <b>CRNF1910</b>       |
| EQUIV 1:                                    | DPI-13145/13231       |
| EQUIV 2:                                    |                       |
| OEM:  | 7C3Z-8005F/7L1Z-8005B |
|   |                       |

RADIADOR AGUA C/S AIRE AUT 800\*700\*26MM (F-350/F-450/F-550) T/ SOLDADO



|   |                 |
|---|-----------------|
| <b>FD</b>                                   |                 |
| <b>F-250 6.0L/6.8L SUPER DUTY 2005-2010</b> |                 |
| CÓDIGO:                                     | <b>CRNF1900</b> |
| EQUIV 1:                                    | DPI-2887/35957  |
| EQUIV 2:                                    |                 |
| OEM:  | 6C34-8005DA/JA  |
|   |                 |

RADIADOR AGUA C/S AIRE AUT 750\*780\*32MM (F-350/F-450/F-550) T/ SOLDADO



|                              |                 |
|------------------------------|-----------------|
| <b>FD</b>                    |                 |
| <b>FIESTA 1.3L 2002-2006</b> |                 |
| CÓDIGO:                      | <b>CRNF0200</b> |
| EQUIV 1:                     | 35785           |
| EQUIV 2:                     |                 |
| OEM:                         | 96FB-8005DA     |
|                              |                 |

RADIADOR AGUA C/AIRE STD 510\*350\*16MM T/SOLDADO



|                                    |                 |
|------------------------------------|-----------------|
| <b>FD</b>                          |                 |
| <b>FIESTA 1.6L SEDAN 2011-2019</b> |                 |
| CÓDIGO:                            | <b>CRNF0220</b> |
| EQUIV 1:                           | DPI-13201/36169 |
| EQUIV 2:                           |                 |
| OEM:                               | AE8Z-8005B      |
|                                    |                 |

RADIADOR AGUA C/S AIRE STD/AUT 560\*380\*16MM (FIGO 16-22/ECOS- PORT 13-17) T/SDO

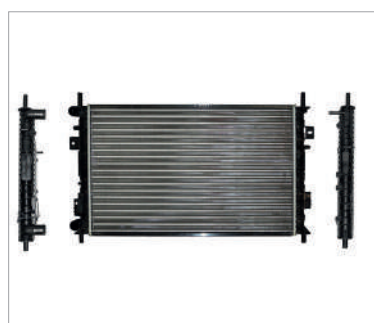

|                                    |                 |
|------------------------------------|-----------------|
| <b>FD</b>                          |                 |
| <b>FIESTA FIRST 1.6L 1998-2010</b> |                 |
| CÓDIGO:                            | <b>CRNF0210</b> |
| EQUIV 1:                           | 35811           |
| EQUIV 2:                           |                 |
| OEM:                               | 2S65-8005AB/CB  |
|                                    |                 |

RADIADOR AGUA C/S AIRE STD 580\*320\*22MM (ECOSPORT 04-12) T/ME- CANICO



|                                   |                 |
|-----------------------------------|-----------------|
| <b>FD</b>                         |                 |
| <b>FIESTA IKON 1.6L 2001-2004</b> |                 |
| CÓDIGO:                           | <b>CRNF0310</b> |
| EQUIV 1:                          | 35808           |
| EQUIV 2:                          |                 |
| OEM:                              | XS6H-8005SB     |
|                                   |                 |

RADIADOR AGUA C/AIRE STD 510\*360\*32MM (COURIER 1.6L 01-10) T/MECANICO



|                                   |                 |
|-----------------------------------|-----------------|
| <b>FD</b>                         |                 |
| <b>FIESTA IKON 1.6L 2001-2007</b> |                 |
| CÓDIGO:                           | <b>CRNF0300</b> |
| EQUIV 1:                          | 35778           |
| EQUIV 2:                          |                 |
| OEM:                              | 2N21-8008AA     |
|                                   |                 |

RADIADOR AGUA S/AIRE STD 520\*420\*26MM T/SOLDADO



|                                   |                 |
|-----------------------------------|-----------------|
| <b>FD</b>                         |                 |
| <b>FIESTA IKON 1.6L 2011-2015</b> |                 |
| CÓDIGO:                           | <b>CRNF0320</b> |
| EQUIV 1:                          |                 |
| EQUIV 2:                          |                 |
| OEM:                              | 6N29-8005DA     |
|                                   |                 |

RADIADOR AGUA C/S AIRE STD 610\*400\*20MM (SEDAN/H-BACK) T/SOLDADO

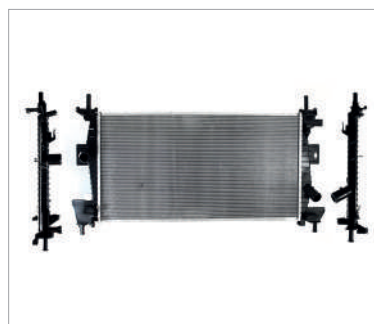

|                             |                 |
|-----------------------------|-----------------|
| <b>FD</b>                   |                 |
| <b>FOCUS 2.0L 2012-2018</b> |                 |
| CÓDIGO:                     | <b>CRNF0110</b> |
| EQUIV 1:                    | DPI-13219       |
| EQUIV 2:                    |                 |
| OEM:                        | BV61-8005AD     |
|                             |                 |

RADIADOR AGUA C/S AIRE AUT 680\*350\*16MM T/SOLDADO

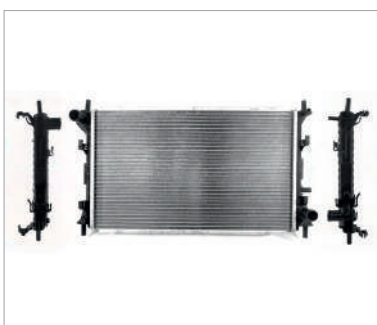

|                                  |                 |
|----------------------------------|-----------------|
| <b>FD</b>                        |                 |
| <b>FOCUS 2.0L/2.3L 2000-2009</b> |                 |
| CÓDIGO:                          | <b>CRNF0100</b> |
| EQUIV 1:                         | DPI-2743        |
| EQUIV 2:                         |                 |
| OEM:                             | 3S4H-8005GB/HB  |
|                                  |                 |

RADIADOR AGUA C/S AIRE AUT 600\*390\*26MM T/SOLDADO



|                                     |                 |
|-------------------------------------|-----------------|
| <b>FD</b>                           |                 |
| <b>FREESTAR 3.0L/4.2L 2000-2007</b> |                 |
| CÓDIGO:                             | <b>CRNF2258</b> |
| EQUIV 1:                            | DPI-2258/35631  |
| EQUIV 2:                            |                 |
| OEM:                                | 1F2Z-8005AA     |
|                                     |                 |

RADIADOR AGUA C/S AIRE AUT 780\*460\*26MM (WINDSTAR 3.0L-3.8L 99-03) T/SOLDADO



|                          |                     |
|--------------------------|---------------------|
| <b>FD</b>                |                     |
| <b>KA 1.6L 2001-2008</b> |                     |
| CÓDIGO:                  | <b>CRNF1510</b>     |
| EQUIV 1:                 | 35740               |
| EQUIV 2:                 |                     |
| OEM:                     | XS5H-8005KC/1085636 |
|                          |                     |

RADIADOR AGUA C/S AIRE STD 400\*360\*16MM C/TUBO RETORNO (RO-CAM) T/MECANICO

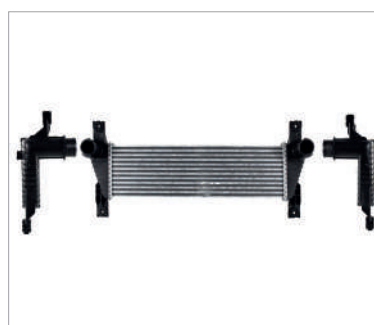

|                                     |                          |
|-------------------------------------|--------------------------|
| <b>FD</b>                           |                          |
| <b>RANGER 2.2L DIESEL 2013-2020</b> |                          |
| CÓDIGO:                             | <b>CRNF0400</b>          |
| EQUIV 1:                            |                          |
| EQUIV 2:                            |                          |
| OEM:                                | UK01-13550/U209-13550E-F |
|                                     |                          |

INTERCOOLER DE TURBO DURATORQ TCDI





|                              |                 |
|------------------------------|-----------------|
| <b>FD</b>                    |                 |
| <b>RANGER 2.3L 2002-2012</b> |                 |
| CÓDIGO:                      | <b>CRNF0450</b> |
| EQUIV 1:                     | DPI-2470/35771  |
| EQUIV 2:                     |                 |
| OEM:                         | 6L5Z-8005AA     |
|                              |                 |

RADIADOR AGUA C/S AIRE AUT 640\*550\*26MM (MZ B2300 2.3L) T/SOLDADO



|  |                 |
|--|-----------------|
| <b>FD</b>                              |                 |
| <b>RANGER 2.3L/3.0L/4.0L 1998-2009</b> |                 |
| CÓDIGO:                                | <b>CRNF0440</b> |
| EQUIV 1:                               | DPI-2173/35770  |
| EQUIV 2:                               |                 |
| OEM:                                   | 6L2Z-8005AA     |
|  |                 |

RADIADOR AGUA C/S AIRE AUT 550\*600\*26MM (EXPLORER 97-08/B3000/B4000) T/SOLDADO



|                                   |                 |
|-----------------------------------|-----------------|
| <b>FD</b>                         |                 |
| <b>TRANSIT 2.2L TDI 2007-2013</b> |                 |
| CÓDIGO:                           | <b>CRNF0600</b> |
| EQUIV 1:                          | DPI-13184/36155 |
| EQUIV 2:                          |                 |
| OEM:                              | 9T1Z-8005A/B    |
|                                   |                 |

RADIADOR AGUA C/S AIRE AUT 700\*400\*26MM T/SOLDADO



|                                     |                 |
|-------------------------------------|-----------------|
| <b>FD</b>                           |                 |
| <b>WINDSTAR 3.0L/3.8L 1995-1998</b> |                 |
| CÓDIGO:                             | <b>CRNF1400</b> |
| EQUIV 1:                            | DPI-1609/35635  |
| EQUIV 2:                            |                 |
| OEM:                                | F58H-8005A      |
|                                     |                 |

RADIADOR AGUA C/S AIRE AUT 780\*460\*26MM T/SOLDADO



|                              |                 |
|------------------------------|-----------------|
| <b>HD</b>                    |                 |
| <b>ACCORD 2.3L 1998-2002</b> |                 |
| CÓDIGO:                      | <b>CRNH0170</b> |
| EQUIV 1:                     | DPI-2148/35794  |
| EQUIV 2:                     |                 |
| OEM:                         | 19010-PAA-A01   |
|                              |                 |

RADIADOR AGUA C/S AIRE AUT 700\*390\*16MM T/SOLDADO



|                              |                           |
|------------------------------|---------------------------|
| <b>HD</b>                    |                           |
| <b>ACCORD 2.4L 2003-2007</b> |                           |
| CÓDIGO:                      | <b>CRNH0110</b>           |
| EQUIV 1:                     | DPI-2569-2797-2911/35873  |
| EQUIV 2:                     | 35969                     |
| OEM:                         | 19010-RAA-A71/A72/PCA-014 |
|                              |                           |

RADIADOR AGUA C/S AIRE AUT 720\*410\*16MM T/SOLDADO



|                                   |                 |
|-----------------------------------|-----------------|
| <b>HD</b>                         |                 |
| <b>ACCORD 2.4L/3.5L 2013-2017</b> |                 |
| CÓDIGO:                           | <b>CRNH0140</b> |
| EQUIV 1:                          | DPI-13363/36202 |
| EQUIV 2:                          |                 |
| OEM:                              | 19010-5A2-A01   |
|                                   |                 |

RADIADOR AGUA C/S AIRE AUT 760\*410\*16MM (ACURA TLX 2.4L 15-20) T/SOLDADO



|                              |                   |
|------------------------------|-------------------|
| <b>HD</b>                    |                   |
| <b>ACCORD 3.0L 2003-2007</b> |                   |
| CÓDIGO:                      | <b>CRNH0100</b>   |
| EQUIV 1:                     | DPI-2571/35861    |
| EQUIV 2:                     |                   |
| OEM:                         | 19010-RCA-A51/A52 |
|                              |                   |

RADIADOR AGUA C/S AIRE AUT 740\*390\*26MM T/SOLDADO



|                            |                 |
|----------------------------|-----------------|
| <b>HD</b>                  |                 |
| <b>CITY 1.5L 2010-2013</b> |                 |
| CÓDIGO:                    | <b>CRNH0500</b> |
| EQUIV 1:                   | DPI-13068/36078 |
| EQUIV 2:                   |                 |
| OEM:                       | 19010-RB7-Z51   |
|                            |                 |

RADIADOR AGUA C/S AIRE AUT 740\*370\*16MM (FIT 1.5L 09-14) T/SOLDADO



|                            |                 |
|----------------------------|-----------------|
| <b>HD</b>                  |                 |
| <b>CITY 1.5L 2010-2013</b> |                 |
| CÓDIGO:                    | <b>CRNH0510</b> |
| EQUIV 1:                   |                 |
| EQUIV 2:                   |                 |
| OEM:                       | 19010-RB7-Z01   |
|                            |                 |

RADIADOR AGUA C/S AIRE STD 740\*370\*16MM T/SOLDADO



|                            |                 |
|----------------------------|-----------------|
| <b>HD</b>                  |                 |
| <b>CITY 1.5L 2014-2017</b> |                 |
| CÓDIGO:                    | <b>CRNH0520</b> |
| EQUIV 1:                   | 36249           |
| EQUIV 2:                   |                 |
| OEM:                       | 19010-55A-Z51   |
|                            |                 |

RADIADOR AGUA C/S AIRE STD/AUT 620\*430\*16MM T/SOLDADO



|                             |                 |
|-----------------------------|-----------------|
| <b>HD</b>                   |                 |
| <b>CIVIC 1.7L 2001-2005</b> |                 |
| CÓDIGO:                     | <b>CRNH0210</b> |
| EQUIV 1:                    | DPI-2354/35840  |
| EQUIV 2:                    |                 |
| OEM:                        | 19010-PLM-A51   |
|                             |                 |

RADIADOR AGUA C/S AIRE AUT 680\*370\*16MM T/SOLDADO



|                             |                 |
|-----------------------------|-----------------|
| <b>HD</b>                   |                 |
| <b>CIVIC 2.0L 2006-2011</b> |                 |
| CÓDIGO:                     | <b>CRNH0200</b> |
| EQUIV 1:                    | DPI-2926/35941  |
| EQUIV 2:                    |                 |
| OEM:                        | 19010-RNB-A51   |
|                             |                 |

RADIADOR AGUA C/S AIRE AUT 700\*390\*20MM T/SOLDADO



|                             |                   |
|-----------------------------|-------------------|
| <b>HD</b>                   |                   |
| <b>CIVIC 2.0L 2012-2015</b> |                   |
| CÓDIGO:                     | <b>CRNH0240</b>   |
| EQUIV 1:                    | DPI-13221/36171   |
| EQUIV 2:                    |                   |
| OEM:                        | 19010-R1B-A51/A52 |
|                             |                   |

RADIADOR AGUA C/S AIRE AUT 680\*400\*16MM (ACURA ILX 2.4L 12-16) T/SOLDADO



|                            |                 |
|----------------------------|-----------------|
| <b>HD</b>                  |                 |
| <b>CR-V 2.4L 2002-2006</b> |                 |
| CÓDIGO:                    | <b>CRNH0330</b> |
| EQUIV 1:                   | DPI-2443/35854  |
| EQUIV 2:                   |                 |
| OEM:                       | 19010-PPA-A01   |
|                            |                 |

RADIADOR AGUA C/AIRE AUT 760\*420\*16MM (ELEMENT 03-08) T/SOLDADO



|                            |                 |
|----------------------------|-----------------|
| <b>HD</b>                  |                 |
| <b>CR-V 2.4L 2007-2009</b> |                 |
| CÓDIGO:                    | <b>CRNH0300</b> |
| EQUIV 1:                   | DPI-2954/35970  |
| EQUIV 2:                   |                 |
| OEM:                       | 19010-RZA-A51   |
|                            |                 |

RADIADOR AGUA C/S AIRE AUT 750\*420\*20MM T/SOLDADO



|                            |                 |
|----------------------------|-----------------|
| <b>HD</b>                  |                 |
| <b>CR-V 2.4L 2010-2011</b> |                 |
| CÓDIGO:                    | <b>CRNH0310</b> |
| EQUIV 1:                   | DPI-13155/36156 |
| EQUIV 2:                   |                 |
| OEM:                       | 19010-R11-A51   |
|                            |                 |

RADIADOR AGUA C/S AIRE AUT 530\*420\*26MM T/SOLDADO



|                            |                 |
|----------------------------|-----------------|
| <b>HD</b>                  |                 |
| <b>CR-V 2.4L 2012-2016</b> |                 |
| CÓDIGO:                    | <b>CRNH0320</b> |
| EQUIV 1:                   | DPI-13314/36207 |
| EQUIV 2:                   |                 |
| OEM:                       | 19010-5LA-A51   |
|                            |                 |

RADIADOR AGUA C/S AIRE AUT 730\*430\*16MM T/SOLDADO



|                           |                 |
|---------------------------|-----------------|
| <b>HD</b>                 |                 |
| <b>FIT 1.5L 2006-2008</b> |                 |
| CÓDIGO:                   | <b>CRNH0400</b> |
| EQUIV 1:                  | DPI-2955        |
| EQUIV 2:                  |                 |
| OEM:                      | 19010-RME-A51   |
|                           |                 |

RADIADOR AGUA C/S AIRE AUT 670\*340\*16MM T/SOLDADO



|                               |                 |
|-------------------------------|-----------------|
| <b>HD</b>                     |                 |
| <b>ODYSSEY 3.5L 1999-2004</b> |                 |
| CÓDIGO:                       | <b>CRNH1100</b> |
| EQUIV 1:                      | DPI-2270/35832  |
| EQUIV 2:                      |                 |
| OEM:                          | 19010-P8F-A51   |
|                               |                 |

RADIADOR AGUA C/S AIRE AUT 790\*470\*16MM T/SOLDADO



|                               |                 |
|-------------------------------|-----------------|
| <b>HD</b>                     |                 |
| <b>ODYSSEY 3.5L 2005-2010</b> |                 |
| CÓDIGO:                       | <b>CRNH1110</b> |
| EQUIV 1:                      | DPI-2806/35982  |
| EQUIV 2:                      |                 |
| OEM:                          | 19010-RGL-A51   |
|                               |                 |

RADIADOR AGUA C/S AIRE AUT 790\*470\*26MM T/SOLDADO



|                               |                 |
|-------------------------------|-----------------|
| <b>HD</b>                     |                 |
| <b>ODYSSEY 3.5L 2011-2017</b> |                 |
| CÓDIGO:                       | <b>CRNH1120</b> |
| EQUIV 1:                      | DPI-13208/36183 |
| EQUIV 2:                      |                 |
| OEM:                          | 19010-RV0-A51   |
|                               |                 |

RADIADOR AGUA C/S AIRE AUT 790\*470\*16MM T/SOLDADO



|                                  |                 |
|----------------------------------|-----------------|
| <b>HY</b>                        |                 |
| <b>GRAND I-10 1.2L 2015-2020</b> |                 |
| CÓDIGO:                          | <b>CRND0300</b> |
| EQUIV 1:                         |                 |
| EQUIV 2:                         |                 |
| OEM:                             | 25310-0U000     |
|                                  |                 |

RADIADOR AGUA S/AIRE STD 520\*390\*16MM (ATTITUDE 1.6L 12-14/RIO 1.6L 16-17) T/S/O

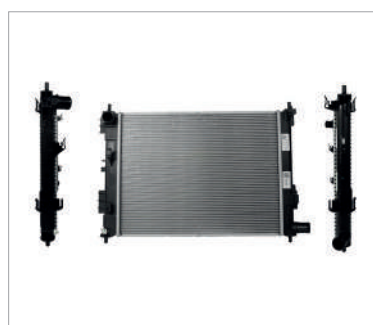

|                           |                 |
|---------------------------|-----------------|
| <b>KA</b>                 |                 |
| <b>RIO 1.6L 2018-2023</b> |                 |
| CÓDIGO:                   | <b>CRNA0100</b> |
| EQUIV 1:                  |                 |
| EQUIV 2:                  |                 |
| OEM:                      | 25310-H9000     |
|                           |                 |

RADIADOR AGUA C/S AIRE STD 520\*400\*16MM (ACCENT 1.6L 18-22) SE-DAN/H-BACK T/S/O

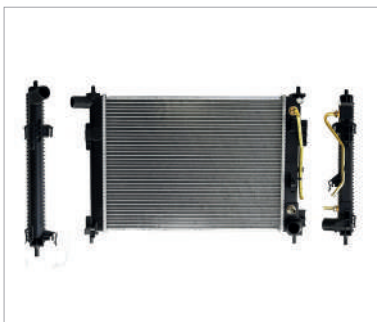

**KA**

**RIO 1.6L 2018-2023**

|          |                 |
|----------|-----------------|
| CÓDIGO:  | <b>CRNA0110</b> |
| EQUIV 1: | DPI-13817       |
| EQUIV 2: |                 |
| OEM:     | 25310-H9050     |



RADIADOR AGUA C/S AIRE AUT 520\*400\*16MM (ACCENT 1.6L 18-22) SEDAN/H-BACK T/SDO



**MZ**

**CX-7 2.3L/2.5L 2007-2012**

|          |                 |
|----------|-----------------|
| CÓDIGO:  | <b>CRNZ0400</b> |
| EQUIV 1: | DPI-2918/35972  |
| EQUIV 2: |                 |
| OEM:     | L33L-15200      |



RADIADOR AGUA C/S AIRE AUT 780\*470\*26MM T/SOLDADO



**MZ**

**CX-9 3.7L 2008-2015**

|          |                 |
|----------|-----------------|
| CÓDIGO:  | <b>CRNZ0800</b> |
| EQUIV 1: | DPI-2986/35973  |
| EQUIV 2: |                 |
| OEM:     | CY03-15200E     |



RADIADOR AGUA C/S AIRE AUT 780\*520\*26MM T/SOLDADO



**MZ**

**MZ 3 2.0L/2.3L 2004-2009**

|          |                 |
|----------|-----------------|
| CÓDIGO:  | <b>CRNZ0110</b> |
| EQUIV 1: | DPI-2696/35943  |
| EQUIV 2: |                 |
| OEM:     | L33X-15200      |



RADIADOR AGUA C/S AIRE AUT 690\*390\*16MM T/SOLDADO



**MZ**

**MZ 3 2.0L/2.3L/2.5L 2010-2013**

|          |                 |
|----------|-----------------|
| CÓDIGO:  | <b>CRNZ0100</b> |
| EQUIV 1: | DPI-13100/36225 |
| EQUIV 2: |                 |
| OEM:     | LF8M-1520YD     |



RADIADOR AGUA C/S AIRE AUT 690\*390\*16MM T/SOLDADO



**MT**

**L200 2.4L GAS 2016-2019**

|          |                 |
|----------|-----------------|
| CÓDIGO:  | <b>CRNS1310</b> |
| EQUIV 1: |                 |
| EQUIV 2: |                 |
| OEM:     | 1350A807        |



RADIADOR AGUA C/S AIRE STD 530\*640\*16MM T/SOLDADO



**MT**

**L200 2.5L DIESEL 2008-2015**

|          |                   |
|----------|-------------------|
| CÓDIGO:  | <b>CRNS1300</b>   |
| EQUIV 1: | 36166             |
| EQUIV 2: |                   |
| OEM:     | MN135032/1350A182 |



RADIADOR AGUA C/S AIRE STD/AUT 660\*540\*26MM T/SOLDADO



**MT**

**L200 2.5L DIESEL 2008-2019**

|          |                 |
|----------|-----------------|
| CÓDIGO:  | <b>CRNS1320</b> |
| EQUIV 1: |                 |
| EQUIV 2: |                 |
| OEM:     | MN135001T       |



INTERCOOLER DE TURBO 4D56

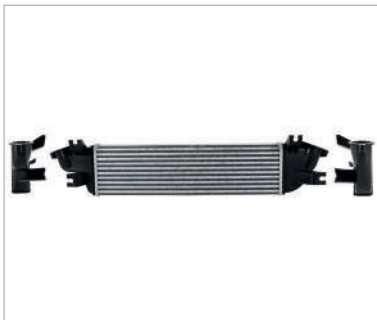

|                                   |                 |
|-----------------------------------|-----------------|
| <b>MT</b>                         |                 |
| <b>L200 2.5L DIESEL 2020-2024</b> |                 |
| CÓDIGO:                           | <b>CRNS1330</b> |
| EQUIV 1:                          |                 |
| EQUIV 2:                          |                 |
| OEM:                              | 1530A161        |
|                                   |                 |

INTERCOOLER DE TURBO 4D56 VGT



|                              |                 |
|------------------------------|-----------------|
| <b>MT</b>                    |                 |
| <b>LANCER 2.0L 2003-2007</b> |                 |
| CÓDIGO:                      | <b>CRNS0500</b> |
| EQUIV 1:                     | DPI-2448/35949  |
| EQUIV 2:                     |                 |
| OEM:                         | MR968858        |
|                              |                 |

RADIADOR AGUA C/S AIRE AUT 710\*390\*16MM T/SOLDADO



|                                   |                 |
|-----------------------------------|-----------------|
| <b>MT</b>                         |                 |
| <b>LANCER 2.0L/2.4L 2008-2016</b> |                 |
| CÓDIGO:                           | <b>CRNS0510</b> |
| EQUIV 1:                          | DPI-2978/36251  |
| EQUIV 2:                          |                 |
| OEM:                              | 1350A050        |
|                                   |                 |

RADIADOR AGUA C/S AIRE AUT 700\*410\*16MM (OUTLANDER 08-13/ASX 13-16) T/SOLDADO



|                                   |                 |
|-----------------------------------|-----------------|
| <b>MT</b>                         |                 |
| <b>LANCER 2.0L/2.4L 2008-2016</b> |                 |
| CÓDIGO:                           | <b>CRNS0520</b> |
| EQUIV 1:                          | DPI-2979/35959  |
| EQUIV 2:                          |                 |
| OEM:                              | MN156092        |
|                                   |                 |

RADIADOR AGUA C/S AIRE STD/AUT 720\*420\*20MM (OUTLANDER 2.4L-3.0L 08-20) T/SO



|                                 |                 |
|---------------------------------|-----------------|
| <b>MT</b>                       |                 |
| <b>OUTLANDER 2.4L 2003-2007</b> |                 |
| CÓDIGO:                         | <b>CRNS0600</b> |
| EQUIV 1:                        | DPI-2617/35950  |
| EQUIV 2:                        |                 |
| OEM:                            | MI3010198       |
|                                 |                 |

RADIADOR AGUA C/S AIRE AUT 710\*450\*26MM T/SOLDADO



|                              |                 |
|------------------------------|-----------------|
| <b>NS</b>                    |                 |
| <b>ALTIMA 2.4L 1993-2001</b> |                 |
| CÓDIGO:                      | <b>CRNN3200</b> |
| EQUIV 1:                     | DPI-1573/35684  |
| EQUIV 2:                     |                 |
| OEM:                         | 21460-0Z000     |
|                              |                 |

RADIADOR AGUA C/S AIRE AUT/STD 710\*400\*32MM T/SOLDADO



|                              |                         |
|------------------------------|-------------------------|
| <b>NS</b>                    |                         |
| <b>ALTIMA 2.5L 2002-2006</b> |                         |
| CÓDIGO:                      | <b>CRNN3210</b>         |
| EQUIV 1:                     | DPI-2414/35843          |
| EQUIV 2:                     |                         |
| OEM:                         | 21460-8J000/21410-8J000 |
|                              |                         |

RADIADOR AGUA C/S AIRE AUT 750\*420\*16MM T/SOLDADO

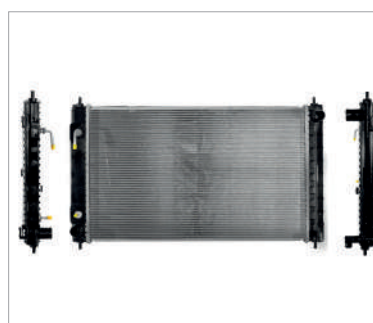

|                                   |                 |
|-----------------------------------|-----------------|
| <b>NS</b>                         |                 |
| <b>ALTIMA 2.5L/3.5L 2007-2018</b> |                 |
| CÓDIGO:                           | <b>CRNN3230</b> |
| EQUIV 1:                          | DPI-2988/36031  |
| EQUIV 2:                          |                 |
| OEM:                              | 21460-JA00A     |
|                                   |                 |

RADIADOR AGUA C/S AIRE AUT 700\*420\*26MM (MAXIMA 3.5L 09-20) T/SOLDADO



|                              |                 |
|------------------------------|-----------------|
| <b>NS</b>                    |                 |
| <b>ALTIMA 3.5L 2002-2006</b> |                 |
| CÓDIGO:                      | <b>CRNN3220</b> |
| EQUIV 1:                     | DPI-13005/35986 |
| EQUIV 2:                     |                 |
| OEM:                         | 21460-ZK30A     |
|                              |                 |

RADIADOR AGUA C/S AIRE AUT 740\*420\*16MM (MAXIMA 04-08/SAFRANE 09-15) T/SOLDADO



|                                  |                   |
|----------------------------------|-------------------|
| <b>NS</b>                        |                   |
| <b>D-21 2/4WD 2.4L 1994-2007</b> |                   |
| CÓDIGO:                          | <b>CRNN0210</b>   |
| EQUIV 1:                         | DPI-314AT/35506LA |
| EQUIV 2:                         |                   |
| OEM:                             | 21450-09G00       |
|                                  |                   |

RADIADOR AGUA C/S AIRE AUT 670\*450\*26MM (PATHFINDER 87-98) T/ SOLDADO

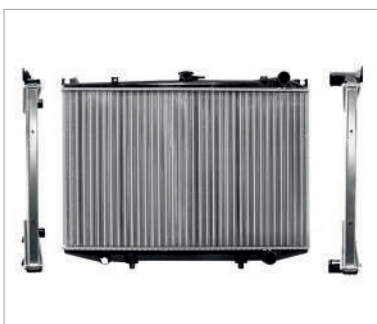

|                                  |                 |
|----------------------------------|-----------------|
| <b>NS</b>                        |                 |
| <b>D-21 2/4WD 2.4L 1994-2007</b> |                 |
| CÓDIGO:                          | <b>CRNN0250</b> |
| EQUIV 1:                         | DPI-314MT/35506 |
| EQUIV 2:                         |                 |
| OEM:                             | 21410-F4003     |
|                                  |                 |

RADIADOR AGUA C/S AIRE STD 670\*450\*22MM T/MECANICO



|                                     |                   |
|-------------------------------------|-------------------|
| <b>NS</b>                           |                   |
| <b>FRONTIER 2.4L/3.3L 1998-2004</b> |                   |
| CÓDIGO:                             | <b>CRNN2700</b>   |
| EQUIV 1:                            | DPI-2151/35816STD |
| EQUIV 2:                            |                   |
| OEM:                                | 21460-4S100/9Z000 |
|                                     |                   |

RADIADOR AGUA C/S AIRE STD 710\*470\*26MM (X-TERRA 00-04) T/SOLDADO



|                                     |                   |
|-------------------------------------|-------------------|
| <b>NS</b>                           |                   |
| <b>FRONTIER 2.4L/3.3L 1998-2004</b> |                   |
| CÓDIGO:                             | <b>CRNN2710</b>   |
| EQUIV 1:                            | DPI-2215/35816AU  |
| EQUIV 2:                            |                   |
| OEM:                                | 21410-3S000/92000 |
|                                     |                   |

RADIADOR AGUA C/S AIRE AUT 710\*470\*26MM (X-TERRA 00-04) T/SOLDADO



|                                   |                 |
|-----------------------------------|-----------------|
| <b>NS</b>                         |                 |
| <b>FRONTIER 4.0L V6 2005-2019</b> |                 |
| CÓDIGO:                           | <b>CRNN2720</b> |
| EQUIV 1:                          | DPI-2807/35988  |
| EQUIV 2:                          |                 |
| OEM:                              | 21460-EA215     |
|                                   |                 |

RADIADOR AGUA C/S AIRE AUT 710\*620\*32MM (PATHFINDER 05-12/X-TERRA 05-15) T/SDO



|                              |                     |
|------------------------------|---------------------|
| <b>NS</b>                    |                     |
| <b>MURANO 3.5L 2003-2008</b> |                     |
| CÓDIGO:                      | <b>CRNN2900</b>     |
| EQUIV 1:                     | DPI-2578-2692/35864 |
| EQUIV 2:                     |                     |
| OEM:                         | 21460-CA010         |
|                              |                     |

RADIADOR AGUA C/S AIRE AUT 750\*470\*26MM (QUEST 3.5L 04-09) T/ SOLDADO



|   |                 |
|---|-----------------|
| <b>NS</b>                               |                 |
| <b>NP-300 (D-22) 2WD 2.4L 2008-2015</b> |                 |
| CÓDIGO:                                 | <b>CRNN0700</b> |
| EQUIV 1:                                | DPI-2215/35816  |
| EQUIV 2:                                |                 |
| OEM:                                    | 21410-VM50A     |
|   |                 |

RADIADOR AGUA C/S AIRE STD 720\*470\*26MM GASOLINA KA24DE T/ MECANICO

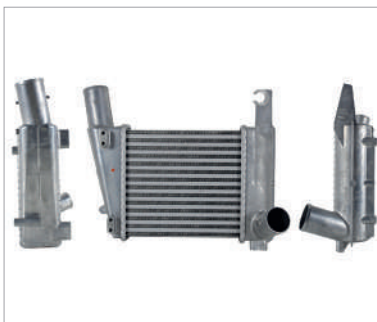

**NS**

**NP-300 (D-22) 4WD 2.5L 2008-2015**

|          |                 |
|----------|-----------------|
| CÓDIGO:  | <b>CRNN0730</b> |
| EQUIV 1: |                 |
| EQUIV 2: |                 |
| OEM:     | 14461-VM00A     |



INTERCOOLER DE TURBO YD25DDTI (DIESEL) (CABSTAR 2.5L 08-18)



**NS**

**NP-300 (D-22) 4WD 2.5L 2008-2015**

|          |                 |
|----------|-----------------|
| CÓDIGO:  | <b>CRNN0750</b> |
| EQUIV 1: | 36086           |
| EQUIV 2: |                 |
| OEM:     | 21410-VM00A     |



RADIADOR AGUA C/S AIRE STD 720\*470\*26MM DIESEL YD25DDTI T/MECANICO

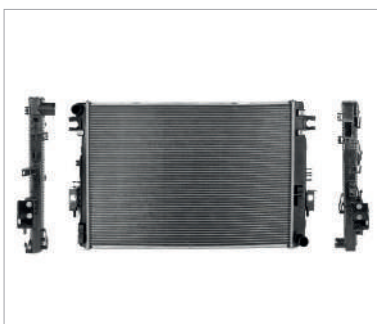

**NS**

**NP-300 FRONTIER (D-23) 2016-2024**

|          |                 |
|----------|-----------------|
| CÓDIGO:  | <b>CRNN0720</b> |
| EQUIV 1: | 36242           |
| EQUIV 2: |                 |
| OEM:     | 21410-4KH0A     |



RADIADOR AGUA C/S AIRE STD 740\*510\*16MM (2.5L GASOLINA) C/SOPORTE T/SOLDADO



**NS**

**NP-300 FRONTIER (D-23) 2018-2024**

|          |                 |
|----------|-----------------|
| CÓDIGO:  | <b>CRNN0710</b> |
| EQUIV 1: |                 |
| EQUIV 2: |                 |
| OEM:     | 14461-4JA0B     |



INTERCOOLER DE TURBO YD25DDTI (2.5L DIESEL) 2/4WD



**NS**

**NV-350 2.5L GAS 2013-2022**

|          |                 |
|----------|-----------------|
| CÓDIGO:  | <b>CRNN0410</b> |
| EQUIV 1: |                 |
| EQUIV 2: |                 |
| OEM:     | 21410-VZ00A     |



RADIADOR AGUA C/S AIRE STD 550\*380\*32MM QR25DE (URVAN 2.5L GAS 07-12) T/MECANICO



**NS**

**PATHFINDER 3.5L 1999-2004**

|          |                   |
|----------|-------------------|
| CÓDIGO:  | <b>CRNN2600</b>   |
| EQUIV 1: | DPI-2459/35759    |
| EQUIV 2: |                   |
| OEM:     | 21460-4W000/4W017 |



RADIADOR AGUA C/S AIRE AUT 700\*520\*16MM T/SOLDADO

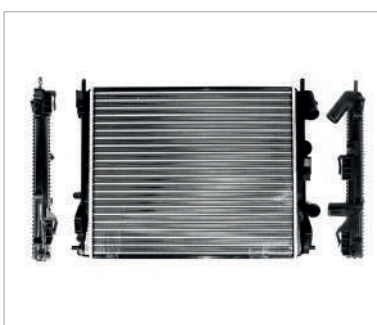

**NS**

**PLATINA 1.6L 2002-2010**

|          |                 |
|----------|-----------------|
| CÓDIGO:  | <b>CRNN0300</b> |
| EQUIV 1: | 8749839/36008   |
| EQUIV 2: |                 |
| OEM:     | 21400-00QAG     |



RADIA AGUA C/S AIRE STD/AUT 500\*420\*22MM (APRIO/CLIO/KANGOO/STEPWAY 10-14) T/MEC



**NS**

**QUEST 3.5L 2004-2009**

|          |                     |
|----------|---------------------|
| CÓDIGO:  | <b>CRNN2510</b>     |
| EQUIV 1: | DPI-2578-2692/35864 |
| EQUIV 2: |                     |
| OEM:     | 21460-5Z200         |



RADIADOR AGUA C/S AIRE AUT 750\*470\*20MM (MURANO 3.5L 03-08) T/SOLDADO



|                             |                 |
|-----------------------------|-----------------|
| <b>NS</b>                   |                 |
| <b>ROGUE 2.5L 2008-2014</b> |                 |
| CÓDIGO:                     | <b>CRNN3600</b> |
| EQUIV 1:                    | DPI-13047       |
| EQUIV 2:                    |                 |
| OEM:                        | 21400-JM00A     |
|                             |                 |

RADIADOR AGUA C/S AIRE AUT 710\*470\*16MM T/SOLDADO



|                                   |                         |
|-----------------------------------|-------------------------|
| <b>NS</b>                         |                         |
| <b>SENTRA B-14 2.0L 1996-2000</b> |                         |
| CÓDIGO:                           | <b>CRNN1200</b>         |
| EQUIV 1:                          | DPI-2328/35679          |
| EQUIV 2:                          |                         |
| OEM:                              | 21410-4Z200/21460-6M200 |
|                                   |                         |

RADIADOR AGUA C/AIRE AUT 700\*380\*16MM T/SOLDADO



|                                   |                 |
|-----------------------------------|-----------------|
| <b>NS</b>                         |                 |
| <b>SENTRA B-15 1.8L 2001-2006</b> |                 |
| CÓDIGO:                           | <b>CRNN1300</b> |
| EQUIV 1:                          | DPI-2327/35678  |
| EQUIV 2:                          |                 |
| OEM:                              | 21410-6M110     |
|                                   |                 |

RADIADOR AGUA C/S AIRE STD 710\*380\*16MM (SCALA 1.6L 10-13) T/ SOLDADO

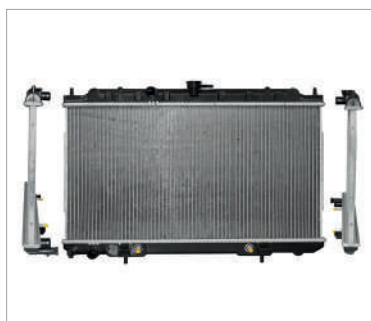

|                                   |                 |
|-----------------------------------|-----------------|
| <b>NS</b>                         |                 |
| <b>SENTRA B-15 1.8L 2001-2006</b> |                 |
| CÓDIGO:                           | <b>CRNN1310</b> |
| EQUIV 1:                          | DPI-2346        |
| EQUIV 2:                          |                 |
| OEM:                              | 21460-6M110     |
|                                   |                 |

RADIADOR AGUA C/S AIRE AUT 710\*380\*16MM (SCALA 1.6L 10-13) T/ SOLDADO

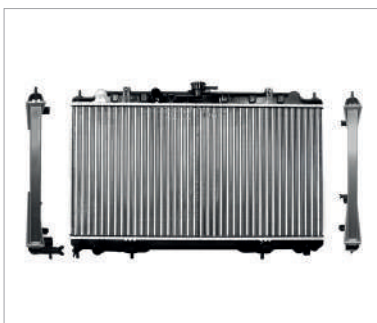

|                                   |                 |
|-----------------------------------|-----------------|
| <b>NS</b>                         |                 |
| <b>SENTRA B-15 1.8L 2001-2006</b> |                 |
| CÓDIGO:                           | <b>CRNN1350</b> |
| EQUIV 1:                          | DPI-2327/35678  |
| EQUIV 2:                          |                 |
| OEM:                              | 21410-6M110     |
|                                   |                 |

RADIADOR AGUA C/S AIRE STD 710\*380\*26MM (SCALA 1.6L 10-13) T/MECANICO



|  |                 |
|--|-----------------|
| <b>NS</b>                              |                 |
| <b>SENTRA B-16 2.0L/2.5L 2007-2012</b> |                 |
| CÓDIGO:                                | <b>CRNN1400</b> |
| EQUIV 1:                               | DPI-2998/36005  |
| EQUIV 2:                               |                 |
| OEM:                                   | 21400-ET000     |
|  |                 |

RADIADOR AGUA C/S AIRE STD/AUT 710\*480\*16MM T/SOLDADO

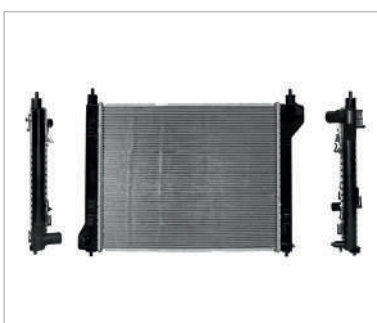

|                                   |                 |
|-----------------------------------|-----------------|
| <b>NS</b>                         |                 |
| <b>SENTRA B-17 1.8L 2013-2020</b> |                 |
| CÓDIGO:                           | <b>CRNN1800</b> |
| EQUIV 1:                          | DPI-13365/36193 |
| EQUIV 2:                          |                 |
| OEM:                              | 21410-3SH0A     |
|                                   |                 |

RADIADOR AGUA C/S AIRE STD/AUT 530\*430\*16MM T/SOLDADO



|                                   |                 |
|-----------------------------------|-----------------|
| <b>NS</b>                         |                 |
| <b>SENTRA B-18 2.0L 2021-2024</b> |                 |
| CÓDIGO:                           | <b>CRNN1600</b> |
| EQUIV 1:                          |                 |
| EQUIV 2:                          |                 |
| OEM:                              | 21410-6LB0B     |
|                                   |                 |

RADIADOR AGUA C/S AIRE STD/AUT 510\*390\*26MM T/SOLDADO





**NS**

**TIIDA 1.6L/1.8L 2006-2017**

|          |                 |
|----------|-----------------|
| CÓDIGO:  | <b>CRNN1110</b> |
| EQUIV 1: | DPI-2981        |
| EQUIV 2: |                 |
| OEM:     | 21460-EL000     |



RADIADOR AGUA C/S AIRE AUT 620\*400\*16MM T/SOLDADO



**NS**

**TIIDA 1.6L/1.8L 2006-2017**

|          |                 |
|----------|-----------------|
| CÓDIGO:  | <b>CRNN1150</b> |
| EQUIV 1: | 35916           |
| EQUIV 2: |                 |
| OEM:     | 21410-EL00A     |



RADIADOR AGUA C/S AIRE STD 620\*400\*16MM T/SOLDADO

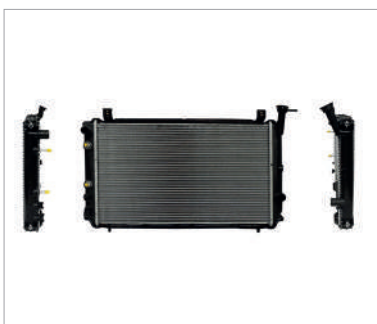

**NS**

**TS-II 1.6L 1988-1991**

|          |                 |
|----------|-----------------|
| CÓDIGO:  | <b>CRNN0500</b> |
| EQUIV 1: | DPI-858/35070   |
| EQUIV 2: |                 |
| OEM:     | 21410-69A00     |



RADIADOR AGUA C/S AIRE STD/AUT 610\*350\*16MM 8VAL T/SOLDADO

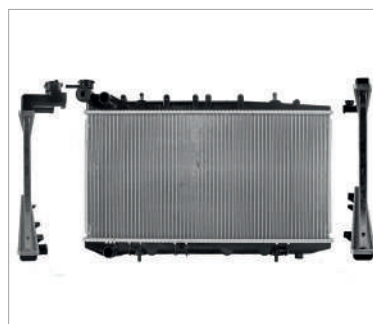

**NS**

**TS-III 1.6L 1992-1994**

|          |                 |
|----------|-----------------|
| CÓDIGO:  | <b>CRNN0110</b> |
| EQUIV 1: | 35074           |
| EQUIV 2: |                 |
| OEM:     | 21410-79Y00     |



RADIADOR AGUA C/S AIRE STD 670\*340\*16MM 8VAL T/SOLDADO



**NS**

**TS-III 1.6L 1992-1994**

|          |                 |
|----------|-----------------|
| CÓDIGO:  | <b>CRNN0140</b> |
| EQUIV 1: |                 |
| EQUIV 2: |                 |
| OEM:     | 21410-75Y00/1   |



RADIADOR AGUA C/S AIRE AUT 670\*340\*16MM 8VAL T/SOLDADO



**NS**

**TS-III 1.6L 1995-2017**

|          |                 |
|----------|-----------------|
| CÓDIGO:  | <b>CRNN0130</b> |
| EQUIV 1: |                 |
| EQUIV 2: |                 |
| OEM:     | 21410-F4202     |



RADIADOR AGUA C/S AIRE AUT 670\*340\*16MM 16VAL T/SOLDADO



**NS**

**TS-III 1.6L 1995-2017**

|          |                   |
|----------|-------------------|
| CÓDIGO:  | <b>CRNN0150</b>   |
| EQUIV 1: | DPI-1977          |
| EQUIV 2: |                   |
| OEM:     | 21410-F4200/62Y01 |



RADIADOR AGUA C/S AIRE STD 670\*340\*26MM 16VAL (SENTRA B-14) T/VALEO T/SOLDADO



**NS**

**TS-III 1.6L 1995-2017**

|          |                   |
|----------|-------------------|
| CÓDIGO:  | <b>CRNN0160</b>   |
| EQUIV 1: | DPI-1977          |
| EQUIV 2: |                   |
| OEM:     | 21410-F4200/62Y01 |



RADIADOR AGUA C/S AIRE STD 670\*340\*20MM 16VAL (SENTRA B-14/TSU-BAME) T/MECANICO



**NS**

### URVAN 2.4L GAS 2002-2006

|          |                 |
|----------|-----------------|
| CÓDIGO:  | <b>CRNN0400</b> |
| EQUIV 1: | 35804           |
| EQUIV 2: |                 |
| OEM:     | 21410-VW000     |



RADIADOR AGUA C/S AIRE STD 550\*380\*32MM KA24DE T/SOLDADO

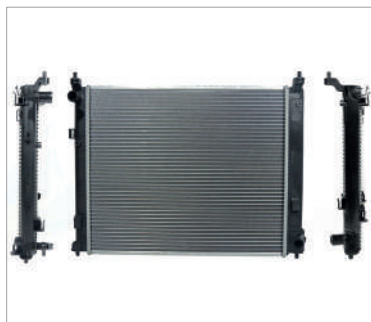

**NS**

### VERSA 1.6L 2012-2019

|          |                 |
|----------|-----------------|
| CÓDIGO:  | <b>CRNN0900</b> |
| EQUIV 1: | DPI-13261/36179 |
| EQUIV 2: |                 |
| OEM:     | 21410-1HS3A     |



RADIADOR AGUA C/S AIRE STD 520\*430\*20MM (V-DRIVE/MARCH/NOTE/MICRA) T/SOLDADO

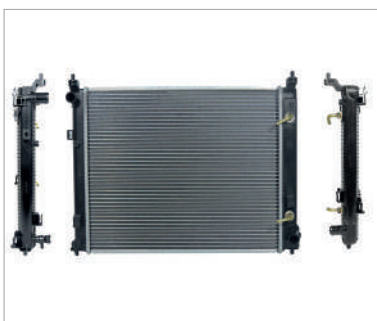

**NS**

### VERSA 1.6L 2012-2019

|          |                 |
|----------|-----------------|
| CÓDIGO:  | <b>CRNN0910</b> |
| EQUIV 1: | DPI-13303/13260 |
| EQUIV 2: |                 |
| OEM:     | 21460-1HS3A     |



RADIADOR AGUA C/S AIRE AUT 520\*430\*20MM (V-DRIVE/MARCH/NOTE/MICRA) T/SOLDADO

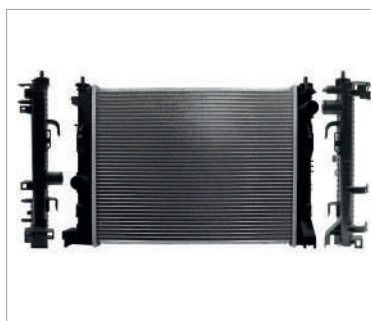

**NS**

### VERSA 1.6L 2020-2024

|          |                 |
|----------|-----------------|
| CÓDIGO:  | <b>CRNN0920</b> |
| EQUIV 1: |                 |
| EQUIV 2: |                 |
| OEM:     | 21410-5RB0A     |



RADIADOR AGUA C/S AIRE STD 530\*410\*16MM (KICKS 17-24) T/SOLDADO

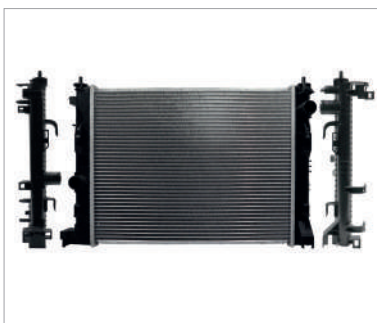

**NS**

### VERSA 1.6L 2020-2024

|          |                 |
|----------|-----------------|
| CÓDIGO:  | <b>CRNN0930</b> |
| EQUIV 1: | DPI-13786/36332 |
| EQUIV 2: |                 |
| OEM:     | 21410-5RB0B     |



RADIADOR AGUA C/S AIRE AUT 530\*410\*26MM (KICKS 17-24) T/SOLDADO

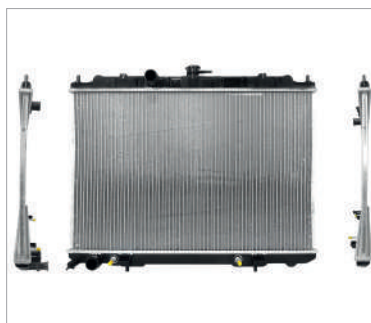

**NS**

### X-TRAIL 2.5L 2001-2007

|          |                 |
|----------|-----------------|
| CÓDIGO:  | <b>CRNN2200</b> |
| EQUIV 1: | 35858           |
| EQUIV 2: |                 |
| OEM:     | 21400-JG80A     |



RADIADOR AGUA C/S AIRE AUT 710\*470\*16MM T/SOLDADO



**NS**

### X-TRAIL 2.5L 2008-2014

|          |                 |
|----------|-----------------|
| CÓDIGO:  | <b>CRNN2210</b> |
| EQUIV 1: | DPI-13047/36004 |
| EQUIV 2: |                 |
| OEM:     | 21400-JG300     |



RADIADOR AGUA C/S AIRE AUT 710\*470\*20MM T/SOLDADO



**PG**

### PARTNER 1.6L 2007-2012

|          |                 |
|----------|-----------------|
| CÓDIGO:  | <b>CRNP0200</b> |
| EQUIV 1: | 36011           |
| EQUIV 2: |                 |
| OEM:     | 1330-F5/S5/W2   |



RADIADOR AGUA C/S AIRE STD 570\*380\*22MM (GRAND RAID 04-06) T/MECANICO



|                               |                 |
|-------------------------------|-----------------|
| <b>PG</b>                     |                 |
| <b>PARTNER 1.6L 2013-2019</b> |                 |
| CÓDIGO:                       | <b>CRNP0210</b> |
| EQUIV 1:                      | 36250           |
| EQUIV 2:                      |                 |
| OEM:                          | 1333-91         |
|                               |                 |

RADIADOR AGUA C/S AIRE STD 570\*380\*26MM (PG-207-208-2008-301-308-3008) T/MEC

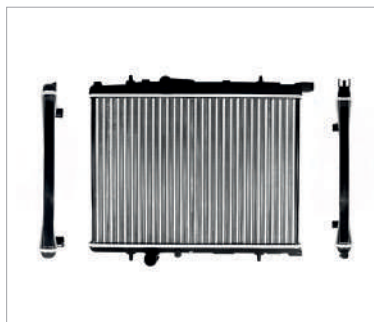

|                                   |                 |
|-----------------------------------|-----------------|
| <b>PG</b>                         |                 |
| <b>PG-206 1.4L/1.6L 1999-2009</b> |                 |
| CÓDIGO:                           | <b>CRNP0100</b> |
| EQUIV 1:                          | 35903           |
| EQUIV 2:                          |                 |
| OEM:                              | 7328-86         |
|                                   |                 |

RADIADOR AGUA C/S AIRE STD 550\*400\*22MM T/MECANICO



|                              |                 |
|------------------------------|-----------------|
| <b>PG</b>                    |                 |
| <b>PG-207 1.6L 2008-2013</b> |                 |
| CÓDIGO:                      | <b>CRNP0500</b> |
| EQUIV 1:                     |                 |
| EQUIV 2:                     |                 |
| OEM:                         | 1330-W9         |
|                              |                 |

RADIADOR AGUA C/S AIRE STD 400\*380\*22MM (PG-208 1.6L 14-20) T/MECANICO

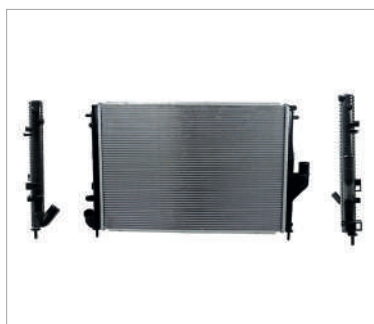

|                              |                 |
|------------------------------|-----------------|
| <b>RT</b>                    |                 |
| <b>DUSTER 2.0L 2013-2016</b> |                 |
| CÓDIGO:                      | <b>CRNR0400</b> |
| EQUIV 1:                     | 36206           |
| EQUIV 2:                     |                 |
| OEM:                         | 21410-0598R     |
|                              |                 |

RADIADOR AGUA C/S AIRE STD/AUT 600\*410\*26MM (SANDERO-STEPWAY 15-16) T/SOLDADO



|                              |                 |
|------------------------------|-----------------|
| <b>RT</b>                    |                 |
| <b>MEGANE 2.0L 2001-2004</b> |                 |
| CÓDIGO:                      | <b>CRNR0300</b> |
| EQUIV 1:                     | 36012           |
| EQUIV 2:                     |                 |
| OEM:                         | 77004-25842     |
|                              |                 |

RADIADOR AGUA C/S AIRE STD 600\*420\*22MM (SANDERO 10-15/SCENIC 01-04) T/MECANICO



|                               |                 |
|-------------------------------|-----------------|
| <b>SZ</b>                     |                 |
| <b>GRAND VITARA 2006-2015</b> |                 |
| CÓDIGO:                       | <b>CRNY0100</b> |
| EQUIV 1:                      | DPI-2920/36042  |
| EQUIV 2:                      |                 |
| OEM:                          | 17700-66J10     |
|                               |                 |

RADIADOR AGUA C/S AIRE AUT 700\*470\*20MM (2.4L/2.7L/3.2L) T/SOLDADO



|                            |                 |
|----------------------------|-----------------|
| <b>SZ</b>                  |                 |
| <b>SX-4 2.0L 2007-2014</b> |                 |
| CÓDIGO:                    | <b>CRNY0500</b> |
| EQUIV 1:                   | DPI-2980/36189  |
| EQUIV 2:                   |                 |
| OEM:                       | 17700-80J10     |
|                            |                 |

RADIADOR AGUA C/S AIRE AUT 720\*390\*26MM T/SOLDADO



|                               |                 |
|-------------------------------|-----------------|
| <b>TY</b>                     |                 |
| <b>4RUNNER 4.0L 2003-2009</b> |                 |
| CÓDIGO:                       | <b>CRNT0510</b> |
| EQUIV 1:                      | DPI-2580/35975  |
| EQUIV 2:                      |                 |
| OEM:                          | 16400-31350     |
|                               |                 |

RADIADOR AGUA C/S AIRE AUT 670\*610\*26MM (FJ CRUISER 08-14) T/SOLDADO



|                               |                         |
|-------------------------------|-------------------------|
| <b>TY</b>                     |                         |
| <b>4RUNNER 4.7L 2003-2009</b> |                         |
| CÓDIGO:                       | <b>CRNT0520</b>         |
| EQUIV 1:                      | DPI-2581/35924          |
| EQUIV 2:                      |                         |
| OEM:                          | 16400-50300/16400-30141 |
|                               |                         |

RADIADOR AGUA C/S AIRE AUT 670\*610\*26MM T/SOLDADO

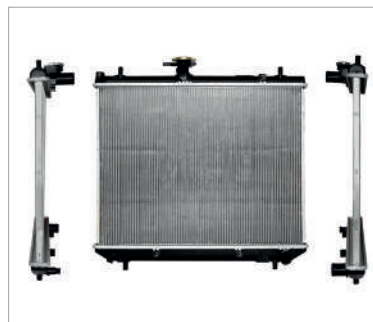

|                              |                 |
|------------------------------|-----------------|
| <b>TY</b>                    |                 |
| <b>AVANZA 1.5L 2007-2015</b> |                 |
| CÓDIGO:                      | <b>CRNT2000</b> |
| EQUIV 1:                     |                 |
| EQUIV 2:                     |                 |
| OEM:                         | 16400-BZ450     |
|                              |                 |

RADIADOR AGUA C/S AIRE STD 570\*450\*16MM T/SOLDADO

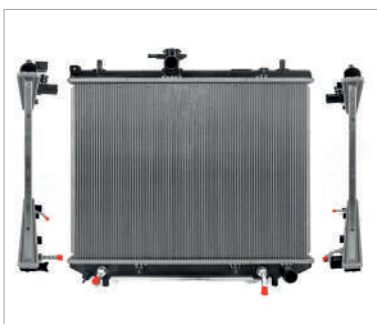

|                              |                 |
|------------------------------|-----------------|
| <b>TY</b>                    |                 |
| <b>AVANZA 1.5L 2007-2015</b> |                 |
| CÓDIGO:                      | <b>CRNT2010</b> |
| EQUIV 1:                     | 36165           |
| EQUIV 2:                     |                 |
| OEM:                         | 16400-BZ460     |
|                              |                 |

RADIADOR AGUA C/S AIRE AUT 570\*450\*16MM T/SOLDADO



|                             |                         |
|-----------------------------|-------------------------|
| <b>TY</b>                   |                         |
| <b>CAMRY 2.4L 2002-2006</b> |                         |
| CÓDIGO:                     | <b>CRNT0100</b>         |
| EQUIV 1:                    | DPI-2437/35853          |
| EQUIV 2:                    |                         |
| OEM:                        | 16400-0H030/16400-28280 |
|                             |                         |

RADIADOR AGUA C/S AIRE AUT 750\*420\*16MM T/SOLDADO



|                             |                   |
|-----------------------------|-------------------|
| <b>TY</b>                   |                   |
| <b>CAMRY 2.4L 2007-2011</b> |                   |
| CÓDIGO:                     | <b>CRNT0120</b>   |
| EQUIV 1:                    | DPI-2917/35974    |
| EQUIV 2:                    |                   |
| OEM:                        | 16400-0H210/0H220 |
|                             |                   |

RADIADOR AGUA C/S AIRE AUT 750\*420\*16MM T/SOLDADO



|                                  |                 |
|----------------------------------|-----------------|
| <b>TY</b>                        |                 |
| <b>CAMRY 2.5L/3.5L 2012-2017</b> |                 |
| CÓDIGO:                          | <b>CRNT0140</b> |
| EQUIV 1:                         | DPI-13270/36181 |
| EQUIV 2:                         |                 |
| OEM:                             | 16400-0V120     |
|                                  |                 |

RADIADOR AGUA C/S AIRE AUT 780\*420\*16MM T/SOLDADO



|                             |                   |
|-----------------------------|-------------------|
| <b>TY</b>                   |                   |
| <b>CAMRY 3.0L 2002-2006</b> |                   |
| CÓDIGO:                     | <b>CRNT0110</b>   |
| EQUIV 1:                    | DPI-2434/35871    |
| EQUIV 2:                    |                   |
| OEM:                        | 16400-0A240/20270 |
|                             |                   |

RADIADOR AGUA C/S AIRE AUT 750\*420\*26MM T/SOLDADO



|                             |                 |
|-----------------------------|-----------------|
| <b>TY</b>                   |                 |
| <b>CAMRY 3.5L 2007-2011</b> |                 |
| CÓDIGO:                     | <b>CRNT0130</b> |
| EQUIV 1:                    | DPI-2817/36013  |
| EQUIV 2:                    |                 |
| OEM:                        | 16400-AD010     |
|                             |                 |

RADIADOR AGUA C/S AIRE AUT 780\*420\*16MM T/SOLDADO



|                               |                 |
|-------------------------------|-----------------|
| <b>TY</b>                     |                 |
| <b>COROLLA 1.8L 2009-2020</b> |                 |
| CÓDIGO:                       | <b>CRNT0230</b> |
| EQUIV 1:                      | DPI-13106/36134 |
| EQUIV 2:                      |                 |
| OEM:                          | 16410-0T030     |
|                               |                 |

RADIADOR AGUA C/S AIRE AUT 620\*390\*20MM (MATRIX 09-14) T/SOLDADO



|                               |                 |
|-------------------------------|-----------------|
| <b>TY</b>                     |                 |
| <b>COROLLA 2.4L 2009-2013</b> |                 |
| CÓDIGO:                       | <b>CRNT0220</b> |
| EQUIV 1:                      | DPI-13049/36134 |
| EQUIV 2:                      |                 |
| OEM:                          | 16410-0H260     |
|                               |                 |

RADIADOR AGUA C/S AIRE AUT 620\*390\*26MM (MATRIX 09-14) T/SOLDADO



|                             |                 |
|-----------------------------|-----------------|
| <b>TY</b>                   |                 |
| <b>HIACE 2.7L 2005-2019</b> |                 |
| CÓDIGO:                     | <b>CRNT0400</b> |
| EQUIV 1:                    | 36076           |
| EQUIV 2:                    |                 |
| OEM:                        | 16400-75470     |
|                             |                 |

RADIADOR AGUA C/S AIRE STD 680\*510\*32MM T/SOLDADO



|                             |                 |
|-----------------------------|-----------------|
| <b>TY</b>                   |                 |
| <b>HIACE 2.7L 2005-2019</b> |                 |
| CÓDIGO:                     | <b>CRNT0410</b> |
| EQUIV 1:                    | 36076           |
| EQUIV 2:                    |                 |
| OEM:                        | 16400-75470     |
|                             |                 |

RADIADOR AGUA C/S AIRE STD 680\*510\*32MM (TODO ALUMINIO) T/SOLDADO



|                                  |                 |
|----------------------------------|-----------------|
| <b>TY</b>                        |                 |
| <b>HIACE 2.8L/3.5L 2020-2024</b> |                 |
| CÓDIGO:                          | <b>CRNT0420</b> |
| EQUIV 1:                         |                 |
| EQUIV 2:                         |                 |
| OEM:                             | 16400-31B40     |
|                                  |                 |

RADIADOR AGUA C/S AIRE STD MM (DIESEL/GASOLINA) T/SOLDADO



|                                  |                 |
|----------------------------------|-----------------|
| <b>TY</b>                        |                 |
| <b>HIGHLANDER 3.5L 2008-2013</b> |                 |
| CÓDIGO:                          | <b>CRNT1410</b> |
| EQUIV 1:                         | DPI-13024/36283 |
| EQUIV 2:                         |                 |
| OEM:                             | 16041-31550     |
|                                  |                 |

RADIADOR AGUA C/S AIRE AUT 780\*500\*26MM T/SOLDADO



|                             |                 |
|-----------------------------|-----------------|
| <b>TY</b>                   |                 |
| <b>HILUX 2.7L 2006-2015</b> |                 |
| CÓDIGO:                     | <b>CRNT0700</b> |
| EQUIV 1:                    | 36017           |
| EQUIV 2:                    |                 |
| OEM:                        | 16400-0C160     |
|                             |                 |

RADIADOR AGUA C/S AIRE STD 680\*550\*20MM T/SOLDADO



|                                    |                 |
|------------------------------------|-----------------|
| <b>TY</b>                          |                 |
| <b>HILUX 2.8L DIESEL 2016-2024</b> |                 |
| CÓDIGO:                            | <b>CRNT0710</b> |
| EQUIV 1:                           |                 |
| EQUIV 2:                           |                 |
| OEM:                               | 16400-0L361     |
|                                    |                 |

RADIADOR AGUA C/S AIRE STD 670\*560\*26MM T/SOLDADO



TY

## HILUX 2.8L DIESEL 2016-2024

|          |             |
|----------|-------------|
| CÓDIGO:  | CRNT0711    |
| EQUIV 1: |             |
| EQUIV 2: |             |
| OEM:     | 16400-0L390 |



RADIADOR AGUA C/S AIRE AUT 670\*560\*26MM T/SOLDADO

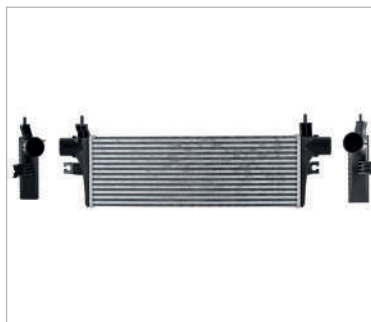

TY

## HILUX 2.8L DIESEL 2016-2024

|          |             |
|----------|-------------|
| CÓDIGO:  | CRNT0720    |
| EQUIV 1: |             |
| EQUIV 2: |             |
| OEM:     | 17940-0L110 |



INTERCOOLER DE TURBO 1GD-FTV



TY

## PCIK-UP 2.4L 1984-1995

|          |               |
|----------|---------------|
| CÓDIGO:  | CRNT1310      |
| EQUIV 1: | DPI-945/35732 |
| EQUIV 2: |               |
| OEM:     | 16400-35110   |



RADIADOR AGUA C/S AIRE AUT 510\*400\*26MM (22RE/4RUNNER 84-95) T/ SOLDADO



TY

## PICK-UP 2.4L 1984-1995

|          |             |
|----------|-------------|
| CÓDIGO:  | CRNT1300    |
| EQUIV 1: |             |
| EQUIV 2: |             |
| OEM:     | 16400-35330 |



RADIADOR AGUA C/S AIRE STD 510\*400\*26MM (22RE/4RUNNER 84-95) T/ SOLDADO



TY

## RAV-4 2.4L/2.5L 2006-2018

|          |                |
|----------|----------------|
| CÓDIGO:  | CRNT0620       |
| EQUIV 1: | DPI-2891/35866 |
| EQUIV 2: |                |
| OEM:     | 16400-28570    |



RADIADOR AGUA C/S AIRE AUT 690\*430\*20MM S/HOYO P/ENFRIADOR ACEITE T/SOLDADO



TY

## RAV-4 2.5L/3.5L 2006-2018

|          |                |
|----------|----------------|
| CÓDIGO:  | CRNT0630       |
| EQUIV 1: | DPI-2893/35867 |
| EQUIV 2: |                |
| OEM:     | 16400-31430    |



RADIADOR AGUA C/S AIRE AUT 690\*470\*26MM C/HOYO P/ENFRIADOR ACEITE T/SOLDADO



TY

## SIENNA 3.5L 2006-2010

|          |                   |
|----------|-------------------|
| CÓDIGO:  | CRNT1210          |
| EQUIV 1: | DPI-13076/35976   |
| EQUIV 2: |                   |
| OEM:     | 16041-0P200/0P201 |



RADIADOR AGUA C/S AIRE AUT 700\*490\*26MM T/SOLDADO



TY

## SIENNA 3.5L 2011-2020

|          |                 |
|----------|-----------------|
| CÓDIGO:  | CRNT1220        |
| EQUIV 1: | DPI-13117/36153 |
| EQUIV 2: |                 |
| OEM:     | 16041-0P220     |



RADIADOR AGUA C/S AIRE AUT 790\*470\*26MM T/SOLDADO



|                                       |                 |
|---------------------------------------|-----------------|
| <b>TY</b>                             |                 |
| <b>TACOMA 2WD 2.4L/2.7L 1995-2004</b> |                 |
| CÓDIGO:                               | <b>CRNT1600</b> |
| EQUIV 1:                              | DPI-1778/35821  |
| EQUIV 2:                              |                 |
| OEM:                                  | 16410-07061     |
|                                       |                 |

RADIADOR AGUA C/S AIRE AUT 670\*500\*16MM T/SOLDADO



|  |                   |
|--|-------------------|
| <b>TY</b>                                |                   |
| <b>TACOMA 2WD 2.7L/3.4L V6 1995-2004</b> |                   |
| CÓDIGO:                                  | <b>CRNT1610</b>   |
| EQUIV 1:                                 | DPI-1774/35591    |
| EQUIV 2:                                 |                   |
| OEM:                                     | 16410-07060/0C020 |
|  |                   |

RADIADOR AGUA C/S AIRE AUT 670\*440\*32MM T/SOLDADO



|  |                 |
|--|-----------------|
| <b>TY</b>                                |                 |
| <b>TACOMA 4WD 2.7L/3.4L V6 1995-2004</b> |                 |
| CÓDIGO:                                  | <b>CRNT1611</b> |
| EQUIV 1:                                 | DPI-1755/35817  |
| EQUIV 2:                                 |                 |
| OEM:                                     | 16410-0C040     |
|  |                 |

RADIADOR AGUA C/S AIRE AUT 650\*380\*26MM T/SOLDADO



|                             |                 |
|-----------------------------|-----------------|
| <b>TY</b>                   |                 |
| <b>YARIS 1.5L 2006-2017</b> |                 |
| CÓDIGO:                     | <b>CRNT0300</b> |
| EQUIV 1:                    | DPI-2890        |
| EQUIV 2:                    |                 |
| OEM:                        | 16400-21270     |
|                             |                 |

RADIADOR AGUA C/S AIRE STD 500\*370\*16MM T/SOLDADO



|                             |                 |
|-----------------------------|-----------------|
| <b>TY</b>                   |                 |
| <b>YARIS 1.5L 2006-2017</b> |                 |
| CÓDIGO:                     | <b>CRNT0310</b> |
| EQUIV 1:                    | DPI-2890/35977  |
| EQUIV 2:                    |                 |
| OEM:                        | 16400-21300     |
|                             |                 |

RADIADOR AGUA C/S AIRE AUT 500\*370\*16MM T/SOLDADO



|                             |                 |
|-----------------------------|-----------------|
| <b>TY</b>                   |                 |
| <b>YARIS 1.5L 2018-2020</b> |                 |
| CÓDIGO:                     | <b>CRNT0320</b> |
| EQUIV 1:                    | DPI-13579       |
| EQUIV 2:                    |                 |
| OEM:                        | 16400-0Y191     |
|                             |                 |

RADIADOR AGUA C/S AIRE STD 640\*370\*16MM T/SOLDADO



|                             |                 |
|-----------------------------|-----------------|
| <b>TY</b>                   |                 |
| <b>YARIS 1.5L 2018-2020</b> |                 |
| CÓDIGO:                     | <b>CRNT0330</b> |
| EQUIV 1:                    |                 |
| EQUIV 2:                    |                 |
| OEM:                        | 16400-0Y090     |
|                             |                 |

RADIADOR AGUA C/S AIRE AUT 620\*370\*16MM T/SOLDADO



|                              |                 |
|------------------------------|-----------------|
| <b>VK</b>                    |                 |
| <b>AMAROK 2.0L 2011-2022</b> |                 |
| CÓDIGO:                      | <b>CRNV4000</b> |
| EQUIV 1:                     | 36221           |
| EQUIV 2:                     |                 |
| OEM:                         | 2H0-121-253A    |
|                              |                 |

RADIADOR AGUA C/S AIRE STD/AUT 620\*580\*26MM (DIESEL) T/SOLDADO



VK

### BORA 2.5L GAS 2006-2010

|          |                          |
|----------|--------------------------|
| CÓDIGO:  | <b>CRNV0400</b>          |
| EQUIV 1: | DPI-2995/878225F-5/36038 |
| EQUIV 2: |                          |
| OEM:     | 1K0-121-251CJ            |



RADIADOR AGUA C/S AIRE STD/AUT 670\*420\*22MM T/MECANICO



VK

### DERBY 1.8L/2.0L 2001-2009

|          |                 |
|----------|-----------------|
| CÓDIGO:  | <b>CRNV0500</b> |
| EQUIV 1: | 35902           |
| EQUIV 2: |                 |
| OEM:     | 6Q0-121-253     |



RADIADOR AGUA C/AIRE STD 660\*380\*22MM (IBIZA-CORDOBA 01-02) T/MECANICO

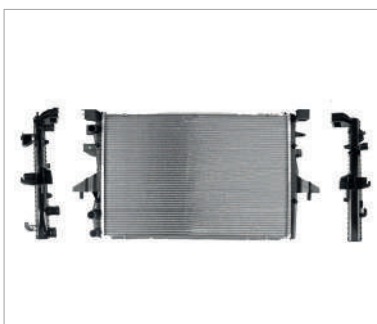

VK

### EUROVAN 1.9L TDI DIESEL 2005-2010

|          |                 |
|----------|-----------------|
| CÓDIGO:  | <b>CRNV1100</b> |
| EQUIV 1: | 36309           |
| EQUIV 2: |                 |
| OEM:     | 7H0-121-253K    |



RADIADOR AGUA S/AIRE STD 730\*480\*26MM T/SOLDADO



VK

### GOL 1.6L 2008-2021

|          |                 |
|----------|-----------------|
| CÓDIGO:  | <b>CRNV0600</b> |
| EQUIV 1: | 36120           |
| EQUIV 2: |                 |
| OEM:     | 5Z0-121-253D    |



RADIADOR AGUA C/AIRE STD 650\*420\*22MM (SAVEIRO 10-22) T/MECANICO

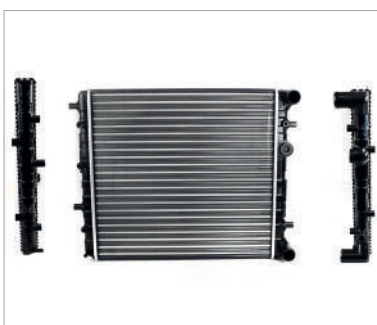

VK

### GOL 1.6L 2008-2021

|          |                 |
|----------|-----------------|
| CÓDIGO:  | <b>CRNV0610</b> |
| EQUIV 1: | 36121           |
| EQUIV 2: |                 |
| OEM:     | 5Z0-121-253C    |



RADIADOR AGUA S/AIRE STD 450\*420\*22MM C/TUBO RETORNO (SAVEIRO 10-22) T/MECANICO

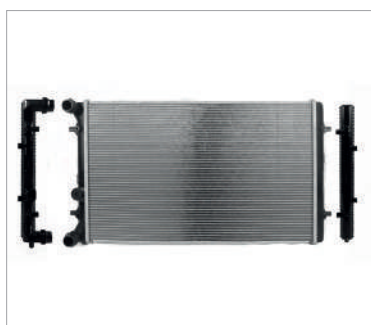

VK

### JETTA A4 1.8L TURBO 1999-2007

|          |                 |
|----------|-----------------|
| CÓDIGO:  | <b>CRNV0122</b> |
| EQUIV 1: | 35901           |
| EQUIV 2: |                 |
| OEM:     | 1J0-121-253AD   |



RADIADOR AGUA C/S AIRE STD/AUT 660\*420\*20MM (GASOLINA) (GOLF A4 TURBO) T/SOLDADO



VK

### JETTA A4/CLASICO 2.0L 1999-2015

|          |                           |
|----------|---------------------------|
| CÓDIGO:  | <b>CRNV0120</b>           |
| EQUIV 1: | DPI-2265/35901M           |
| EQUIV 2: |                           |
| OEM:     | 1J0-121-253N/1K0-121-251E |



RADIADOR AGUA C/S AIRE STD 660\*420\*22MM (GASOLINA) (GOLF A4/LEON/TOLEDO) T/MEC



VK

### JETTA A4/CLASICO 2.0L 1999-2015

|          |                           |
|----------|---------------------------|
| CÓDIGO:  | <b>CRNV0121</b>           |
| EQUIV 1: | DPI-2265/35901M           |
| EQUIV 2: |                           |
| OEM:     | 1J0-121-253N/1K0-121-251E |



RADIADOR AGUA C/S AIRE STD 660\*420\*26MM (GASOLINA) (GOLF A4/LEON/TOLEDO) T/SDO



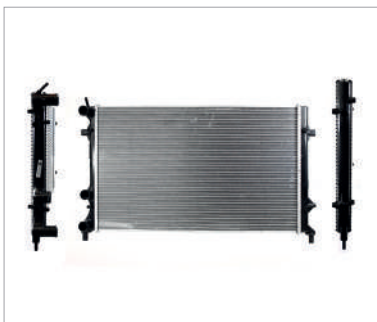

VK

**JETTA A6 BICENTENARIO 2.5L 2010-2018**

|          |                 |
|----------|-----------------|
| CÓDIGO:  | <b>CRNV0110</b> |
| EQUIV 1: | DPI-13215       |
| EQUIV 2: |                 |
| OEM:     | 5C0-121-251D/E  |



RADIADOR AGUA C/S AIRE STD/AUT 650\*400\*20MM (BEETLE 2.5L 12-19) T/SOLDADO



VK

**JETTA A6 GLI 2.0L 2010-2018**

|          |                 |
|----------|-----------------|
| CÓDIGO:  | <b>CRNV0111</b> |
| EQUIV 1: | DPI-2822/36014  |
| EQUIV 2: |                 |
| OEM:     | 1K0-121-251AB   |



RADIADOR AGUA C/S AIRE STD/AUT 670\*460\*32MM (BORA 2.0L/BEETLE 12-19) T/SOLDADO



VK

**JETTA/GOLF A2 1.8L 1987-1992**

|          |                 |
|----------|-----------------|
| CÓDIGO:  | <b>CRNV0101</b> |
| EQUIV 1: |                 |
| EQUIV 2: |                 |
| OEM:     | 191-121-253     |



RADIADOR AGUA C/AIRE STD 690\*320\*32MM S/TUBO RETORNO T/MECANICO



VK

**JETTA/GOLF A2/A3 1.8L 1987-1998**

|          |                 |
|----------|-----------------|
| CÓDIGO:  | <b>CRNV0100</b> |
| EQUIV 1: | DPI-837/35313   |
| EQUIV 2: |                 |
| OEM:     | 321-121-253AL   |



RADIADOR AGUA S/AIRE STD 540\*320\*32MM (CARIBE 77-87) T/MECANICO



VK

**JETTA/GOLF A2/A3 1.8L 1987-1998**

|          |                 |
|----------|-----------------|
| CÓDIGO:  | <b>CRNV0102</b> |
| EQUIV 1: | DPI-CU98/35311  |
| EQUIV 2: |                 |
| OEM:     | 191-121-253C    |



RADIADOR AGUA C/AIRE STD 690\*320\*32MM C/TUBO RETORNO (CARIBE GTI) T/MECANICO



VK

**JETTA/GOLF A3 2.0L 1993-1998**

|          |                 |
|----------|-----------------|
| CÓDIGO:  | <b>CRNV0130</b> |
| EQUIV 1: | DPI-1556/35806  |
| EQUIV 2: |                 |
| OEM:     | 1HM-121-253A    |



RADIADOR AGUA S/AIRE STD 540\*320\*32MM T/MECANICO

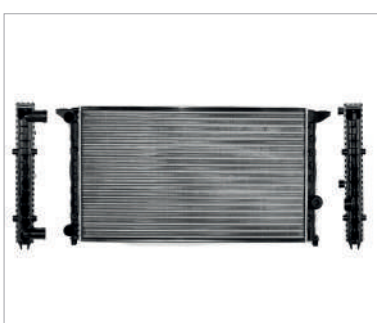

VK

**JETTA/GOLF A3 2.0L 1993-1998**

|          |                 |
|----------|-----------------|
| CÓDIGO:  | <b>CRNV0131</b> |
| EQUIV 1: | DPI-1557/35702  |
| EQUIV 2: |                 |
| OEM:     | 1HM-121-253C    |



RADIADOR AGUA C/AIRE STD 640\*380\*32MM (DERBY 1.8L 95-00) T/MECANICO



VK

**LUPO/POLO 1.6L 2003-2009**

|          |                 |
|----------|-----------------|
| CÓDIGO:  | <b>CRNV1300</b> |
| EQUIV 1: | 36121           |
| EQUIV 2: | SPORT VAN 07-09 |
| OEM:     | 5Z0-121-253     |



RADIADOR AGUA S/AIRE STD 450\*420\*26MM (IBIZA-CORDOBA 03-09/ CROSSFOX 07-09) T/MEC



VK

### LUPO/POLO 1.6L 2003-2009

|          |                 |
|----------|-----------------|
| CÓDIGO:  | <b>CRNV1310</b> |
| EQUIV 1: | 35906           |
| EQUIV 2: | SPORT VAN 07-09 |
| OEM:     | 6Q0-121-253Q    |



RADIADOR AGUA C/AIRE STD 650\*420\*22MM (IBIZA-CORDOBA 03-09/  
CROSSFOX 07-09) T/MEC



VK

### POINTER 1.8L 1998-2009

|          |                 |
|----------|-----------------|
| CÓDIGO:  | <b>CRNV0200</b> |
| EQUIV 1: | 35735           |
| EQUIV 2: |                 |
| OEM:     | 377-121-253B    |



RADIADOR AGUA C/S AIRE STD 490\*340\*32MM (VAGONETA/PICK-UP) T/  
MECANICO

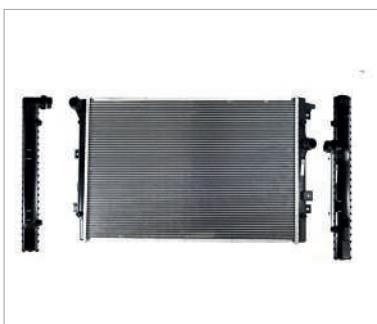

VK

### TIGUAN 1.4L/2.0L 2009-2022

|          |                 |
|----------|-----------------|
| CÓDIGO:  | <b>CRNV5200</b> |
| EQUIV 1: | DPI-13272/36186 |
| EQUIV 2: |                 |
| OEM:     | 5N0-121-253F/H  |



RADIADOR AGUA C/S AIRE STD/AUT 650\*430\*26MM T/SOLDADO



VK

### VENTO 1.6L GAS 2014-2022

|          |                          |
|----------|--------------------------|
| CÓDIGO:  | <b>CRNV0700</b>          |
| EQUIV 1: | 36177                    |
| EQUIV 2: | TOLEDO 13-17/AU A1 11-17 |
| OEM:     | 6R0-121-253              |



RADIADOR AGUA C/S AIRE STD/AUT 660\*330\*22MM (IBIZA 10-17/POLO  
13-19) T/MECANICO



VK

### VIRTUS 1.6L 2020-2024

|          |                 |
|----------|-----------------|
| CÓDIGO:  | <b>CRNV0900</b> |
| EQUIV 1: |                 |
| EQUIV 2: |                 |
| OEM:     | 2GB-121-253A    |



RADIADOR AGUA C/S AIRE STD/AUT 660\*420\*26MM (POLO-T-CROSS 1.6L  
20-24) T/SOLDADO



**AU**

**A1/A3 1.4L 2010-2018**

|          |                 |
|----------|-----------------|
| CÓDIGO:  | <b>MANO0500</b> |
| EQUIV 1: | MBA289030       |
| EQUIV 2: |                 |
| OEM:     | 03C-121-005NV   |



BOMBA AGUA (GOLF A7 13-17/TIGUAN TURBO 1.4L 13-17/LEON-TOLEDO 13-19/ALTEA 10-13)



**CV**

**AVEO 1.5L 2018-2023**

|          |                 |
|----------|-----------------|
| CÓDIGO:  | <b>MANC9910</b> |
| EQUIV 1: | MBA099048       |
| EQUIV 2: |                 |
| OEM:     | 24106088        |



BOMBA AGUA L2B (CAVALIER 1.5L 18-23)



**CV**

**AVEO 1.6L 2007-2017**

|          |                   |
|----------|-------------------|
| CÓDIGO:  | <b>MANC9900</b>   |
| EQUIV 1: | MBA094027/KGP1655 |
| EQUIV 2: |                   |
| OEM:     | 96930074          |



BOMBA AGUA LXT/LXV (PT G3 06-09)



**CV**

**CAPTIVA 2.4L 2008-2015**

|          |                     |
|----------|---------------------|
| CÓDIGO:  | <b>MANC7200</b>     |
| EQUIV 1: | MBA095092/KGP9228   |
| EQUIV 2: | CAVALIER-ASTRA 2.2L |
| OEM:     | 24439798            |



BOMBA AGUA (MALIBU 2.2L-2.4L/EQUINOX 2.4L/HHR 2.2L-2.4L/VECTRA 2.2L/ZAFIRA 2.2L)



**CV**

**CHEVY 1.4L/1.6L 1994-2012**

|          |                    |
|----------|--------------------|
| CÓDIGO:  | <b>MANC0100</b>    |
| EQUIV 1: | MBA092364/KGP9376  |
| EQUIV 2: |                    |
| OEM:     | 93278547/88926172G |



BOMBA AGUA (C-2/C-3/CHEVY PICK-UP 99-04)



**CV**

**COLORADO 2.8L/2.9L 2004-2012**

|          |                   |
|----------|-------------------|
| CÓDIGO:  | <b>MANC5200</b>   |
| EQUIV 1: | MBA095097/KGP9234 |
| EQUIV 2: |                   |
| OEM:     | 12620226          |



BOMBA AGUA 3.5L/3.7L (TRAILBLAZER 4.2L 02-09/HUMMER H3 3.5L-3.7L 06-10)



**CV**

**CORSA 1.8L 2003-2008**

|          |                   |
|----------|-------------------|
| CÓDIGO:  | <b>MANC0200</b>   |
| EQUIV 1: | MBA091619/KGP1619 |
| EQUIV 2: |                   |
| OEM:     | 24587027          |



BOMBA AGUA 19DIENTES (TORNADO 04-11/MERIVA 04-08/PALIO 1.8L)



**CV**

**CORSA 1.8L 2003-2008**

|          |                   |
|----------|-------------------|
| CÓDIGO:  | <b>MANC0210</b>   |
| EQUIV 1: | MBA091642/KGP4027 |
| EQUIV 2: |                   |
| OEM:     | 90543935          |



BOMBA AGUA 23DIENTES (ASTRA 1.8L-2.0L 00-06/ZAFIRA 1.8L 02-06/VECTRA 02-06)



|                                   |                   |
|-----------------------------------|-------------------|
| <b>CV</b>                         |                   |
| <b>MATIZ G1/G2 1.0L 2003-2015</b> |                   |
| CÓDIGO:                           | <b>MANG0100</b>   |
| EQUIV 1:                          | MBA091646/KGP1640 |
| EQUIV 2:                          |                   |
| OEM:                              | 25194440          |
|                                   |                   |

BOMBA AGUA



|                                 |                 |
|---------------------------------|-----------------|
| <b>CV</b>                       |                 |
| <b>ONIX 1.0L/1.2L 2020-2024</b> |                 |
| CÓDIGO:                         | <b>MANC0500</b> |
| EQUIV 1:                        |                 |
| EQUIV 2:                        |                 |
| OEM:                            | 55505442        |
|                                 |                 |

BOMBA AGUA L4F/L4H



|                             |                   |
|-----------------------------|-------------------|
| <b>CV</b>                   |                   |
| <b>OPTRA 2.0L 2006-2010</b> |                   |
| CÓDIGO:                     | <b>MANC1700</b>   |
| EQUIV 1:                    | MBA091447/KGP1447 |
| EQUIV 2:                    |                   |
| OEM:                        | 24579450          |
|                             |                   |

BOMBA AGUA 25DIENTES (ASTRA 2.4L 00-06/LUV 2.2L 99-05/VECTRA 02-06)



|                                      |                        |
|--------------------------------------|------------------------|
| <b>CV</b>                            |                        |
| <b>SILVERADO 1500 4.3L 1999-2013</b> |                        |
| CÓDIGO:                              | <b>MANC2600</b>        |
| EQUIV 1:                             | MBA09968/KGP9020       |
| EQUIV 2:                             | ASTRO 4.3L/BLAZER 4.3L |
| OEM:                                 | 88926225               |
|                                      |                        |

BOMBA AGUA C/POLEA (C1500-C2500-C3500 4.3L-4.5L-5.7L/SUBURBAN-YUKON 5.7L 96-99)



|                                      |                          |
|--------------------------------------|--------------------------|
| <b>CV</b>                            |                          |
| <b>SILVERADO 1500 4.3L 2014-2018</b> |                          |
| CÓDIGO:                              | <b>MANC2630</b>          |
| EQUIV 1:                             | MBA099035                |
| EQUIV 2:                             | TAHOE 5.3L/ESCALADE 6.2L |
| OEM:                                 | 89018166                 |
|                                      |                          |

BOMBA AGUA C/POLEA (SUBURBAN 5.3L/SIERRA 1500 4.3L-5.3L-6.2L/YUKON 4.2L-5.3L)



|                                 |                  |
|---------------------------------|------------------|
| <b>CV</b>                       |                  |
| <b>SILVERADO 5.3L 1999-2006</b> |                  |
| CÓDIGO:                         | <b>MANC2620</b>  |
| EQUIV 1:                        | MBA09692/KGP9106 |
| EQUIV 2:                        |                  |
| OEM:                            | 12458935         |
|                                 |                  |

BOMBA AGUA C/POLEA (AVALANCHE 5.3L/YUKON 5.3L/ESCALADE 5.3L)



|                                 |                   |
|---------------------------------|-------------------|
| <b>CV</b>                       |                   |
| <b>SILVERADO 6.0L 2007-2013</b> |                   |
| CÓDIGO:                         | <b>MANC2610</b>   |
| EQUIV 1:                        | MBA091106/KGP1106 |
| EQUIV 2:                        |                   |
| OEM:                            | 12681417          |
|                                 |                   |

BOMBA AGUA C/POLEA (EXPRESS VAN 4.8L-5.3L-6.0L/YUKON 5.3L-6.2L)



|                             |                   |
|-----------------------------|-------------------|
| <b>CV</b>                   |                   |
| <b>SONIC 1.6L 2012-2018</b> |                   |
| CÓDIGO:                     | <b>MANC0900</b>   |
| EQUIV 1:                    | MBA091700/KGP1902 |
| EQUIV 2:                    |                   |
| OEM:                        | 25195119          |
|                             |                   |

BOMBA AGUA LDE (CRUZE 1.8L 10-15/TRAX 1.8L 13-20)

# BOMBA DE AGUA



|                             |                   |
|-----------------------------|-------------------|
| <b>CV</b>                   |                   |
| <b>SPARK 1.2L 2011-2017</b> |                   |
| CÓDIGO:                     | <b>MANC0800</b>   |
| EQUIV 1:                    | MBA099014/KGP9413 |
| EQUIV 2:                    |                   |
| OEM:                        | 19346593          |
|                             |                   |

BOMBA AGUA S/BASE C/POLEA SMARTECH II (BEAT 1.2L 18-21)



|                             |                     |
|-----------------------------|---------------------|
| <b>CV</b>                   |                     |
| <b>SPARK 1.2L 2011-2017</b> |                     |
| CÓDIGO:                     | <b>MANC0810</b>     |
| EQUIV 1:                    | MBA099014BH/KGP9414 |
| EQUIV 2:                    |                     |
| OEM:                        | 25194461            |
|                             |                     |

BOMBA AGUA C/BASE C/POLEA SMARTECH II (BEAT 1.2L 18-21)



|                                |                 |
|--------------------------------|-----------------|
| <b>CV</b>                      |                 |
| <b>SPARK NG 1.4L 2016-2021</b> |                 |
| CÓDIGO:                        | <b>MANC0820</b> |
| EQUIV 1:                       | MBA099040       |
| EQUIV 2:                       |                 |
| OEM:                           | 12667385        |
|                                |                 |

BOMBA AGUA S/BASE C/POLEA LV7 (CRUZE-TRAX-ENCORE 1.4L/MALIBU-EQUINOX 1.5L)



|                                |                   |
|--------------------------------|-------------------|
| <b>CV</b>                      |                   |
| <b>UPLANDER 3.9L 2007-2009</b> |                   |
| CÓDIGO:                        | <b>MANC6900</b>   |
| EQUIV 1:                       | MBA092061/KGP2061 |
| EQUIV 2:                       |                   |
| OEM:                           | 89060479          |
|                                |                   |

BOMBA AGUA (MALIBU 3.5L-3.9L/IMPALA 3.5L-3.9L/G6 3.5L-3.9L)



|                               |                  |
|-------------------------------|------------------|
| <b>CV</b>                     |                  |
| <b>VENTURE 3.4L 1997-2005</b> |                  |
| CÓDIGO:                       | <b>MANC2300</b>  |
| EQUIV 1:                      | MBA09864/KGP-625 |
| EQUIV 2:                      |                  |
| OEM:                          | 93429123         |
|                               |                  |

BOMBA AGUA (CAVALIER 2.8L-3.1L/IMPALA 3.4L/G6 3.5L/UPLANDER 3.5L/MALIBU 3.5L)



|                            |                 |
|----------------------------|-----------------|
| <b>DG</b>                  |                 |
| <b>ATOS 1.0L 2000-2004</b> |                 |
| CÓDIGO:                    | <b>MANK0100</b> |
| EQUIV 1:                   |                 |
| EQUIV 2:                   |                 |
| OEM:                       | 25100-02501     |
|                            |                 |

BOMBA AGUA

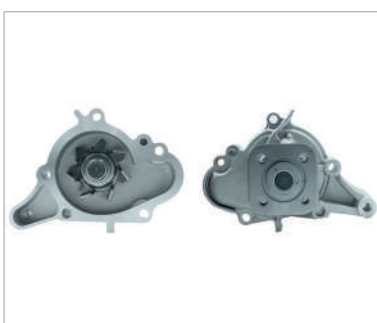

|                            |                  |
|----------------------------|------------------|
| <b>DG</b>                  |                  |
| <b>ATOS 1.1L 2005-2012</b> |                  |
| CÓDIGO:                    | <b>MANK0110</b>  |
| EQUIV 1:                   | MBA05972/KGP1645 |
| EQUIV 2:                   |                  |
| OEM:                       | 25100-02566      |
|                            |                  |

BOMBA AGUA (I-10 11-14)



|                                |                   |
|--------------------------------|-------------------|
| <b>DG</b>                      |                   |
| <b>ATTITUDE 1.2L 2015-2024</b> |                   |
| CÓDIGO:                        | <b>MANK1100</b>   |
| EQUIV 1:                       | MBA199033/KGP1913 |
| EQUIV 2:                       |                   |
| OEM:                           | 1300A095          |
|                                |                   |

BOMBA AGUA (MT MIRAGE G4 19-24/MIRAGE 1.2L 15-19)

# BOMBA DE AGUA



|                                |                 |
|--------------------------------|-----------------|
| <b>DG</b>                      |                 |
| <b>ATTITUDE 1.4L 2006-2011</b> |                 |
| CÓDIGO:                        | <b>MANK1120</b> |
| EQUIV 1:                       | MBA05842/KGP602 |
| EQUIV 2:                       |                 |
| OEM:                           | 25100-21000     |
|                                |                 |

BOMBA AGUA (VERNA 1.5L 04-06)



|                                |                   |
|--------------------------------|-------------------|
| <b>DG</b>                      |                   |
| <b>ATTITUDE 1.6L 2006-2011</b> |                   |
| CÓDIGO:                        | <b>MANK1110</b>   |
| EQUIV 1:                       | MBA059139/KGP9139 |
| EQUIV 2:                       |                   |
| OEM:                           | 25100-26902       |
|                                |                   |

BOMBA AGUA (VERNA 1.6L 04-06)



|                               |                           |
|-------------------------------|---------------------------|
| <b>DG</b>                     |                           |
| <b>CARAVAN 3.3L 1990-2000</b> |                           |
| CÓDIGO:                       | <b>MANK0730</b>           |
| EQUIV 1:                      | MBA05897/KGP732           |
| EQUIV 2:                      | T&COUNTRY 3.3L-3.8L 90-00 |
| OEM:                          | 4654392AB                 |
|                               |                           |

BOMBA AGUA (G.CARAVAN-G.VOYAGER-VOYAGER 3.3L-3.8L/CARAVAN 3.8L 96-99)



|                                     |                 |
|-------------------------------------|-----------------|
| <b>DG</b>                           |                 |
| <b>GRAND CARAVAN 3.0L 1994-2000</b> |                 |
| CÓDIGO:                             | <b>MANK0720</b> |
| EQUIV 1:                            | MBA05911/KGP662 |
| EQUIV 2:                            |                 |
| OEM:                                | MD972003        |
|                                     |                 |

BOMBA AGUA (G.VOYAGER 92-00/SPIRIT 89-95/SHADOW 92-95/NEW YORKER/LEBARON)



|                                     |                   |
|-------------------------------------|-------------------|
| <b>DG</b>                           |                   |
| <b>GRAND CARAVAN 3.3L 2001-2007</b> |                   |
| CÓDIGO:                             | <b>MANK0710</b>   |
| EQUIV 1:                            | MBA057165/KGP9210 |
| EQUIV 2:                            |                   |
| OEM:                                | 4781157AA         |
|                                     |                   |

BOMBA AGUA (TOWN & COUNTRY 3.3L/VOYAGER 3.3L)



|                                     |                   |
|-------------------------------------|-------------------|
| <b>DG</b>                           |                   |
| <b>GRAND CARAVAN 3.8L 2008-2019</b> |                   |
| CÓDIGO:                             | <b>MANK0700</b>   |
| EQUIV 1:                            | MBA052156/KGP2156 |
| EQUIV 2:                            |                   |
| OEM:                                | 4648952AE         |
|                                     |                   |

BOMBA AGUA (TOWN & COUNTRY 3.8L/VW ROUTAN 3.8L)



|                                      |                   |
|--------------------------------------|-------------------|
| <b>DG</b>                            |                   |
| <b>GRAND CHEROKEE 4.0L 1999-2004</b> |                   |
| CÓDIGO:                              | <b>MANK1300</b>   |
| EQUIV 1:                             | MBA057164/KGP9200 |
| EQUIV 2:                             |                   |
| OEM:                                 | 5012366AD         |
|                                      |                   |

BOMBA AGUA (WRANGKER 4.0L 00-06)



|                             |                   |
|-----------------------------|-------------------|
| <b>DG</b>                   |                   |
| <b>H-100 2.5L 2006-2012</b> |                   |
| CÓDIGO:                     | <b>MANK1410</b>   |
| EQUIV 1:                    | MBA051855/KGP1440 |
| EQUIV 2:                    |                   |
| OEM:                        | 25100-42540       |
|                             |                   |

BOMBA AGUA (DIESEL) (H-100 VAN 10-14)

# BOMBA DE AGUA



|                               |                   |
|-------------------------------|-------------------|
| <b>DG</b>                     |                   |
| <b>JOURNEY 2.4L 2009-2020</b> |                   |
| CÓDIGO:                       | <b>MANK8120</b>   |
| EQUIV 1:                      | MBA051982/KGP1445 |
| EQUIV 2:                      |                   |
| OEM:                          | 5047138AA         |
|                               |                   |

BOMBA AGUA (CALIBER 2.0L-2.4L 07-12/AVENGER 2.0L-2.4L 07-14/200 2.4L 11-14)



|                               |                         |
|-------------------------------|-------------------------|
| <b>DG</b>                     |                         |
| <b>JOURNEY 3.5L 2009-2011</b> |                         |
| CÓDIGO:                       | <b>MANK8100</b>         |
| EQUIV 1:                      | MBA051107/KGP1107       |
| EQUIV 2:                      | 300 3.5L/VW ROUTAN 4.0L |
| OEM:                          | 4792968AA/AD            |
|                               |                         |

BOMBA AGUA (CHARGER-AVENGER-SEBRING 3.5L/G.CARAVAN-T&COUNTRY-PACIFICA-NITRO 4.0L)



|                               |                         |
|-------------------------------|-------------------------|
| <b>DG</b>                     |                         |
| <b>JOURNEY 3.6L 2012-2020</b> |                         |
| CÓDIGO:                       | <b>MANK8110</b>         |
| EQUIV 1:                      | MBA059011/KGP2408       |
| EQUIV 2:                      | G.CHEROKEE 3.6L/200/300 |
| OEM:                          | 5184498AI               |
|                               |                         |

BOMBA AGUA C/POLEA (CHARGER 3.6L/CHALLENGER 3.6L/DURANGO 3.6L/G.CARAVAN-T&C 3.6L)

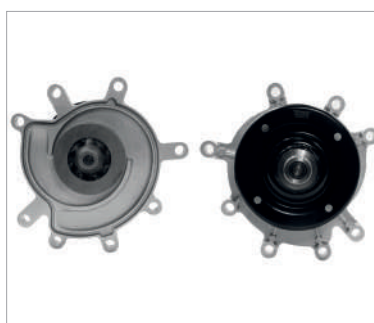

|                               |                  |
|-------------------------------|------------------|
| <b>DG</b>                     |                  |
| <b>LIBERTY 3.7L 2002-2013</b> |                  |
| CÓDIGO:                       | <b>MANK3600</b>  |
| EQUIV 1:                      | MBA05927/KGP9240 |
| EQUIV 2:                      |                  |
| OEM:                          | 53022189AH       |
|                               |                  |

BOMBA AGUA C/POLEA (DURANGO 3.7L-4.7L/NITRO 3.7L/G.CHEROKEE 3.7L-4.7L)



|                                    |                   |
|------------------------------------|-------------------|
| <b>DG</b>                          |                   |
| <b>PATRIOT 2.0L/2.4L 2007-2017</b> |                   |
| CÓDIGO:                            | <b>MANK9900</b>   |
| EQUIV 1:                           | MBA051982/KGP1445 |
| EQUIV 2:                           |                   |
| OEM:                               | 68046026AA        |
|                                    |                   |

BOMBA AGUA (COMPASS 2.0L-2.4L 07-19/OUTLANDER 2.0L-2.4L 08-20/CHEROKEE 09-14)



|                               |                  |
|-------------------------------|------------------|
| <b>DG</b>                     |                  |
| <b>STRATUS 2.0L 1995-2000</b> |                  |
| CÓDIGO:                       | <b>MANK0400</b>  |
| EQUIV 1:                      | MBA05996/KGP9024 |
| EQUIV 2:                      |                  |
| OEM:                          | 4667660          |
|                               |                  |

BOMBA AGUA (NEON 2.0L/CIRRUS 2.0L/SEBRING 2.0L/AVENGER 2.0L/ECLIPSE 2.0L)



|                               |                   |
|-------------------------------|-------------------|
| <b>DG</b>                     |                   |
| <b>STRATUS 2.4L 1995-2006</b> |                   |
| CÓDIGO:                       | <b>MANK0430</b>   |
| EQUIV 1:                      | MBA052422/KGP9108 |
| EQUIV 2:                      |                   |
| OEM:                          | 4694307AB         |
|                               |                   |

BOMBA AGUA C/ENGRANE (NEON 2.4L/CIRRUS 2.4L/SEBRING 2.4L/PT CRUISER 2.4L)



|                               |                      |
|-------------------------------|----------------------|
| <b>DG</b>                     |                      |
| <b>STRATUS 2.4L 2001-2006</b> |                      |
| CÓDIGO:                       | <b>MANK0420</b>      |
| EQUIV 1:                      | MBA059399/KGP9399    |
| EQUIV 2:                      |                      |
| OEM:                          | MD976943/25100-38200 |
|                               |                      |

BOMBA AGUA C/POLEA (SEBRING-ECLIPSE-GALANT 2.4L/LANCER-OUTLANDER 2.4L 03-07)

# BOMBA DE AGUA

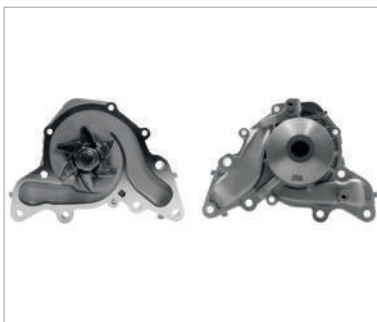

**DG**

## STRATUS 2.5L 1995-2006

|          |                   |
|----------|-------------------|
| CÓDIGO:  | <b>MANK0410</b>   |
| EQUIV 1: | MBA052416/KGP9025 |
| EQUIV 2: |                   |
| OEM:     | MD973025          |



BOMBA AGUA C/POLEA (AVENGER 2.5L 95-00/CIRRUS 2.5L 95-00/STRATUS 3.0L 01-06)

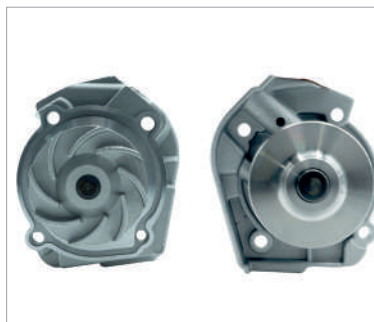

**FT**

## 500 1.4L 2009-2016

|          |                    |
|----------|--------------------|
| CÓDIGO:  | <b>MANB0800</b>    |
| EQUIV 1: | MBA072159/KGP-2159 |
| EQUIV 2: |                    |
| OEM:     | 55184081           |



BOMBA AGUA (DART 1.4L 13-15)

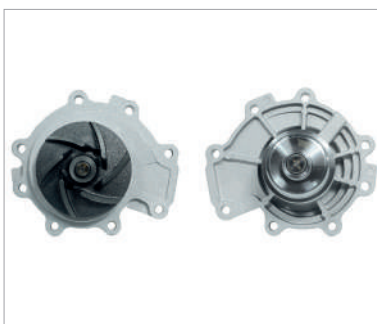

**FD**

## ESCAPE 3.0L 2001-2012

|          |                           |
|----------|---------------------------|
| CÓDIGO:  | <b>MANF0500</b>           |
| EQUIV 1: | MBA08959/KGP9035          |
| EQUIV 2: | TAURUS-TRIBUTE-SABLE 3.0L |
| OEM:     | F63Z-8501AA               |



BOMBA AGUA IMPULSOR ABIERTO (MONDEO-CONTOUR-COUGAR-MYSTIQUE 2.5L/MPV 2.5L-3.0L)

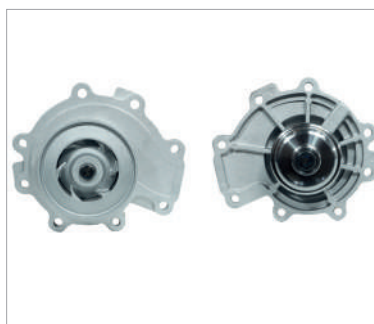

**FD**

## ESCAPE 3.0L 2001-2012

|          |                         |
|----------|-------------------------|
| CÓDIGO:  | <b>MANF0510</b>         |
| EQUIV 1: | MBA089320/KGP9412       |
| EQUIV 2: |                         |
| OEM:     | 2S7Z-8501BG/5L8Z-8501AA |



BOMBA AGUA IMPULSOR SEMIABIERTO (FUSION 3.0L 06-12/MZ 6 3.0L 03-08)



**FD**

## ESCAPE 3.0L 2008-2012

|          |                   |
|----------|-------------------|
| CÓDIGO:  | <b>MANF0520</b>   |
| EQUIV 1: | MBA089422/KGP2249 |
| EQUIV 2: |                   |
| OEM:     | 9L8Z-8501C        |



BOMBA AGUA (FUSION 3.0L 10-12/MARINER 3.0L 08-11)



**FD**

## EXPEDITION 5.4L 2003-2014

|          |                         |
|----------|-------------------------|
| CÓDIGO:  | <b>MANF2900</b>         |
| EQUIV 1: | MBA08992/KGP9097        |
| EQUIV 2: |                         |
| OEM:     | F65Z-8501BA/YC2E-8501BA |



BOMBA AGUA (EXCURSION 5.4L/NAVIGATOR 5.4L/LOBO 4.6L)



**FD**

## EXPLORER 4.6L 2001-2010

|          |                   |
|----------|-------------------|
| CÓDIGO:  | <b>MANF2500</b>   |
| EQUIV 1: | MBA089101/KGP9219 |
| EQUIV 2: |                   |
| OEM:     | 3L3Z-8501CA       |



BOMBA AGUA (EXPEDITION-SUPER DUTY-ECONOLINE-EXCURSION-MOUNTAINNER 4.6L-5.4L)



**FD**

## F-150 3.7L 2011-2014

|          |                   |
|----------|-------------------|
| CÓDIGO:  | <b>MANF1800</b>   |
| EQUIV 1: | MBA089009/KGP2276 |
| EQUIV 2: |                   |
| OEM:     | BR3Z-8501G        |



BOMBA AGUA (MUSTANG 3.7L/TRANSIT 3.7L/MZ 6 3.7L 11-13/CX-9 3.7L 11-15)





|                             |                  |
|-----------------------------|------------------|
| <b>FD</b>                   |                  |
| <b>F-150 4.2L 1997-2008</b> |                  |
| CÓDIGO:                     | <b>MANF1810</b>  |
| EQUIV 1:                    | MBA08979/KGP9100 |
| EQUIV 2:                    |                  |
| OEM:                        | F85Z-8501AA      |
|                             |                  |

BOMBA AGUA (E-150 ECONOLINE 4.2L 97-03)

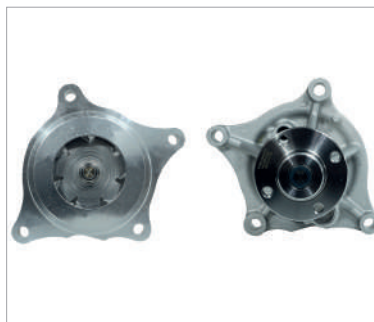

|                             |                   |
|-----------------------------|-------------------|
| <b>FD</b>                   |                   |
| <b>F-150 6.2L 2011-2014</b> |                   |
| CÓDIGO:                     | <b>MANF1830</b>   |
| EQUIV 1:                    | MBA089015/KGP2407 |
| EQUIV 2:                    |                   |
| OEM:                        | AL3E-8501BB       |
|                             |                   |

BOMBA AGUA (F-250 F-350 6.2L SUPER DUTY/E-350 6.2L SUPER DUTY)



|                             |                   |
|-----------------------------|-------------------|
| <b>FD</b>                   |                   |
| <b>F-250 6.4L 2008-2010</b> |                   |
| CÓDIGO:                     | <b>MANF1910</b>   |
| EQUIV 1:                    | MBA089021/KGP2139 |
| EQUIV 2:                    |                   |
| OEM:                        | 8C3Z-8501B        |
|                             |                   |

BOMBA AGUA (F-350 F-450 F-550 6.4L SUPER DUTY 08-10) (DIESEL)



|                              |                   |
|------------------------------|-------------------|
| <b>FD</b>                    |                   |
| <b>FIESTA 1.6L 2011-2019</b> |                   |
| CÓDIGO:                      | <b>MANF0220</b>   |
| EQUIV 1:                     | MBA082157/KGP1910 |
| EQUIV 2:                     |                   |
| OEM:                         | YS6G-8591B2D      |
|                              |                   |

BOMBA AGUA (FIGO 1.5L 16-22/FIESTA IKON 1.6L 11-15/ESCAPE-FUSION 1.6L TURBO)



|                                    |                  |
|------------------------------------|------------------|
| <b>FD</b>                          |                  |
| <b>FIESTA FIRST 1.6L 1998-2010</b> |                  |
| CÓDIGO:                            | <b>MANF0210</b>  |
| EQUIV 1:                           | MBA08546/KGP1620 |
| EQUIV 2:                           |                  |
| OEM:                               | 2S6G-8591AA      |
|                                    |                  |

BOMBA AGUA 16VAL (IKON 98-10/COURIER 01-10/KA 01-08)



|                             |                  |
|-----------------------------|------------------|
| <b>FD</b>                   |                  |
| <b>FOCUS 2.0L 2000-2006</b> |                  |
| CÓDIGO:                     | <b>MANF0100</b>  |
| EQUIV 1:                    | MBA08994/KGP9102 |
| EQUIV 2:                    |                  |
| OEM:                        | F8RZ-8501EN      |
|                             |                  |

BOMBA AGUA (ESCORT 2.0L/ESCAPE 2.0L/COUGAR 2.0L/CONTOUR 2.0L/MYSTIQUE 2.0L)



|                            |                   |
|----------------------------|-------------------|
| <b>FD</b>                  |                   |
| <b>LOBO 5.0L 2011-2016</b> |                   |
| CÓDIGO:                    | <b>MANF3200</b>   |
| EQUIV 1:                   | MBA089010/KGP2415 |
| EQUIV 2:                   |                   |
| OEM:                       | BR3Z-8501H        |
|                            |                   |

BOMBA AGUA (F-150 5.0L 10-16/MUSTANG 5.0L 11-16)



|                              |                          |
|------------------------------|--------------------------|
| <b>FD</b>                    |                          |
| <b>RANGER 2.3L 2002-2012</b> |                          |
| CÓDIGO:                      | <b>MANF0430</b>          |
| EQUIV 1:                     | MBA084126/KGP9216        |
| EQUIV 2:                     | TRANSIT 10-13/MZ 6 09-13 |
| OEM:                         | 1S7Z-8501AK/4S4Z-8501AA  |
|                              |                          |

BOMBA AGUA (ECOSPORT 04-12/ESCAPE 2.3L-2.5L 05-13/MZ 3-5 2.3L-2.5L 04-13)

# BOMBA DE AGUA

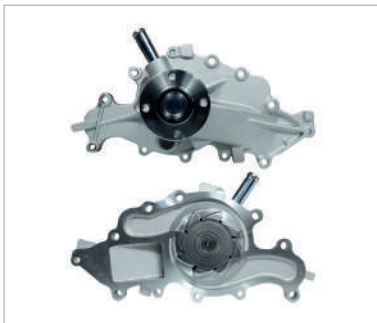

|                              |                        |
|------------------------------|------------------------|
| <b>FD</b>                    |                        |
| <b>RANGER 3.0L 1995-2009</b> |                        |
| CÓDIGO:                      | <b>MANF0410</b>        |
| EQUIV 1:                     | MBA08983/KGP653        |
| EQUIV 2:                     |                        |
| OEM:                         | F49Z-8501A/F87Z-8501DA |
|                              |                        |

BOMBA AGUA (AEROSTAR 3.0L 95-97/B3000 3.0L 94-09)



|                              |                  |
|------------------------------|------------------|
| <b>FD</b>                    |                  |
| <b>RANGER 4.0L 2002-2012</b> |                  |
| CÓDIGO:                      | <b>MANF0400</b>  |
| EQUIV 1:                     | MBA08965/KGP9166 |
| EQUIV 2:                     |                  |
| OEM:                         | F77Z-8501AD      |
|                              |                  |

BOMBA AGUA (EXPLORER 4.0L/MUSTANG 4.0L/MOUNTAINNER 4.0L/B4000 4.0L)

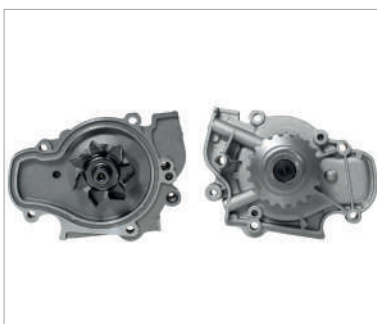

|                              |                  |
|------------------------------|------------------|
| <b>HD</b>                    |                  |
| <b>ACCORD 2.3L 1998-2002</b> |                  |
| CÓDIGO:                      | <b>MANH0120</b>  |
| EQUIV 1:                     | MBA102346/KGP759 |
| EQUIV 2:                     |                  |
| OEM:                         | 19200-P0A-003    |
|                              |                  |

BOMBA AGUA (ACCORD 2.2L 90-97/ODYSSEY 2.2L 95-97 2.3L 1998)



|                              |                   |
|------------------------------|-------------------|
| <b>HD</b>                    |                   |
| <b>ACCORD 2.4L 2003-2007</b> |                   |
| CÓDIGO:                      | <b>MANH0100</b>   |
| EQUIV 1:                     | MBA109313/KGP9314 |
| EQUIV 2:                     |                   |
| OEM:                         | 19200-PNA-003     |
|                              |                   |

BOMBA AGUA C/POLEA (CR-V 2.4L 02-09/CIVIC 2.0L 03-05)



|                              |                 |
|------------------------------|-----------------|
| <b>HD</b>                    |                 |
| <b>ACCORD 3.0L 1998-2002</b> |                 |
| CÓDIGO:                      | <b>MANH0130</b> |
| EQUIV 1:                     | KGP9363         |
| EQUIV 2:                     |                 |
| OEM:                         | 19200-P8A-A03   |
|                              |                 |

BOMBA AGUA (ODYSSEY 3.5L 99-04/PILOT 3.5L 03-04/MDX 3.5L 01-02/CL-TL 3.0L-3.2L)



|                                   |                   |
|-----------------------------------|-------------------|
| <b>HD</b>                         |                   |
| <b>ACCORD 3.0L/3.5L 2003-2012</b> |                   |
| CÓDIGO:                           | <b>MANH0110</b>   |
| EQUIV 1:                          | MBA109201/KGP9201 |
| EQUIV 2:                          |                   |
| OEM:                              | 19200-RCA-A01     |
|                                   |                   |

BOMBA AGUA (PILOT-ODYSSEY-RIDGELINE 3.5L 05-10/ACURA MDX 3.5L 03-07)



|                             |                   |
|-----------------------------|-------------------|
| <b>HD</b>                   |                   |
| <b>CIVIC 1.6L 1997-2000</b> |                   |
| CÓDIGO:                     | <b>MANH0200</b>   |
| EQUIV 1:                    | MBA109207/KGP9207 |
| EQUIV 2:                    |                   |
| OEM:                        | 19200-PLM-A01     |
|                             |                   |

BOMBA AGUA ENGRANE CORTO



|                             |                   |
|-----------------------------|-------------------|
| <b>HD</b>                   |                   |
| <b>CIVIC 1.6L 1997-2000</b> |                   |
| CÓDIGO:                     | <b>MANH0210</b>   |
| EQUIV 1:                    | MBA102459/KGP9120 |
| EQUIV 2:                    |                   |
| OEM:                        | 19200-P2A-A01     |
|                             |                   |

BOMBA AGUA ENGRANE ALTO (CIVIC DEL SOL 1.6L 96-97)

# BOMBA DE AGUA



|                             |                   |
|-----------------------------|-------------------|
| <b>HD</b>                   |                   |
| <b>CIVIC 1.8L 2006-2011</b> |                   |
| CÓDIGO:                     | <b>MANH0220</b>   |
| EQUIV 1:                    | MBA102058/KGP2058 |
| EQUIV 2:                    |                   |
| OEM:                        | 19200-RNA-A01/A02 |
|                             |                   |

BOMBA AGUA



|                            |                 |
|----------------------------|-----------------|
| <b>HD</b>                  |                 |
| <b>CR-V 2.4L 2010-2012</b> |                 |
| CÓDIGO:                    | <b>MANH0300</b> |
| EQUIV 1:                   | KGP2196         |
| EQUIV 2:                   |                 |
| OEM:                       | 19200-R40-A01   |
|                            |                 |

BOMBA AGUA (ACCORD 2.4L 08-12/ACURA TSX 09-14)



|                           |                   |
|---------------------------|-------------------|
| <b>HD</b>                 |                   |
| <b>FIT 1.5L 2009-2014</b> |                   |
| CÓDIGO:                   | <b>MANH0400</b>   |
| EQUIV 1:                  | MBA102280/KGP2059 |
| EQUIV 2:                  |                   |
| OEM:                      | 19200-RB0-003     |
|                           |                   |

BOMBA AGUA (CITY 1.5L 10-17)



|                                  |                 |
|----------------------------------|-----------------|
| <b>HY</b>                        |                 |
| <b>GRAND I-10 1.2L 2015-2023</b> |                 |
| CÓDIGO:                          | <b>MAND0300</b> |
| EQUIV 1:                         | MBA119041       |
| EQUIV 2:                         |                 |
| OEM:                             | 25100-03010     |
|                                  |                 |

BOMBA AGUA



|                           |                   |
|---------------------------|-------------------|
| <b>KA</b>                 |                   |
| <b>RIO 1.6L 2016-2023</b> |                   |
| CÓDIGO:                   | <b>MANA0100</b>   |
| EQUIV 1:                  | MBA112221/KGP2221 |
| EQUIV 2:                  |                   |
| OEM:                      | 25100-2B710       |
|                           |                   |

BOMBA AGUA (ATTITUDE 1.6L 12-14/ACCENT 1.6L 18-22/SOUL 1.6L 16-19) SEDAN/H-BACK



|                                |                   |
|--------------------------------|-------------------|
| <b>MT</b>                      |                   |
| <b>L200 2.4L GAS 2008-2015</b> |                   |
| CÓDIGO:                        | <b>MANS1300</b>   |
| EQUIV 1:                       | MBA199174/KGP9174 |
| EQUIV 2:                       |                   |
| OEM:                           | MD972934/MD300389 |
|                                |                   |

BOMBA AGUA (MONTERO 2.4L/VAN 1000 2.4L)



|                              |                   |
|------------------------------|-------------------|
| <b>MT</b>                    |                   |
| <b>LANCER 2.0L 2003-2007</b> |                   |
| CÓDIGO:                      | <b>MANS0500</b>   |
| EQUIV 1:                     | MBA199171/KGP9171 |
| EQUIV 2:                     |                   |
| OEM:                         | MD309756          |
|                              |                   |

BOMBA AGUA



|                           |                 |
|---------------------------|-----------------|
| <b>NS</b>                 |                 |
| <b>720 1.8L 1986-1993</b> |                 |
| CÓDIGO:                   | <b>MANN0600</b> |
| EQUIV 1:                  | MBA202040       |
| EQUIV 2:                  |                 |
| OEM:                      | 21010-13225     |
|                           |                 |

BOMBA AGUA (DATSUN A-10/J15/J16/J18)

# BOMBA DE AGUA



|                           |                  |
|---------------------------|------------------|
| <b>NS</b>                 |                  |
| <b>720 1.8L 1986-1993</b> |                  |
| CÓDIGO:                   | <b>MANN0610</b>  |
| EQUIV 1:                  | MBA202147/KGP577 |
| EQUIV 2:                  |                  |
| OEM:                      | 21010-N5825      |
|                           |                  |

BOMBA AGUA C/FAN CLUTCH C/POLEA (MOTOR Z-24/J16/J18/510)



|                              |                   |
|------------------------------|-------------------|
| <b>NS</b>                    |                   |
| <b>ALTIMA 2.4L 1993-2001</b> |                   |
| CÓDIGO:                      | <b>MANN3200</b>   |
| EQUIV 1:                     | MBA202453/KGP898  |
| EQUIV 2:                     |                   |
| OEM:                         | 21010-0Z800/1E4Y0 |
|                              |                   |

BOMBA AGUA

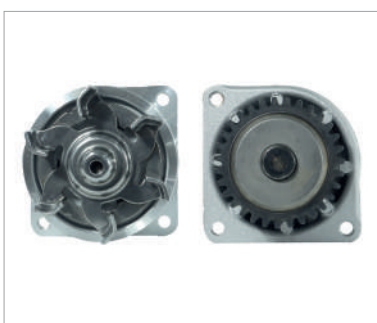

|                              |                   |
|------------------------------|-------------------|
| <b>NS</b>                    |                   |
| <b>ALTIMA 3.5L 2007-2016</b> |                   |
| CÓDIGO:                      | <b>MANN3210</b>   |
| EQUIV 1:                     | MBA209020/KGP2140 |
| EQUIV 2:                     |                   |
| OEM:                         | 21010-JA10A       |
|                              |                   |

BOMBA AGUA (MAXIMA 3.5L 09-15/MURANO 3.5L 09-14/PATHFINDER 3.5L 13-15)



|                                  |                  |
|----------------------------------|------------------|
| <b>NS</b>                        |                  |
| <b>D-21 2/4WD 2.4L 1994-2007</b> |                  |
| CÓDIGO:                          | <b>MANN0200</b>  |
| EQUIV 1:                         | MBA202347/KGP775 |
| EQUIV 2:                         |                  |
| OEM:                             | 21010-86G00      |
|                                  |                  |

BOMBA AGUA KA24E/KA24DE (URVAN 2.4L 02-06/NP-300 2.4L 08-15)

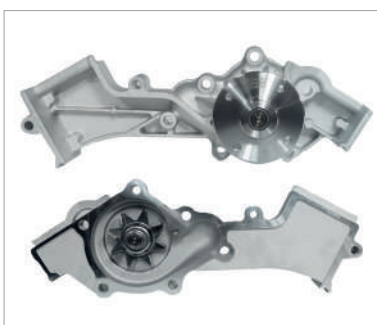

|                                |                   |
|--------------------------------|-------------------|
| <b>NS</b>                      |                   |
| <b>FRONTIER 3.3L 1998-2004</b> |                   |
| CÓDIGO:                        | <b>MANN2700</b>   |
| EQUIV 1:                       | MBA209338/KGP9135 |
| EQUIV 2:                       |                   |
| OEM:                           | 21010-0W025/0W027 |
|                                |                   |

BOMBA AGUA (PATHFINDER 3.3L/X-TERRA 3.3L)



|                                   |                   |
|-----------------------------------|-------------------|
| <b>NS</b>                         |                   |
| <b>FRONTIER 4.0L V6 2005-2019</b> |                   |
| CÓDIGO:                           | <b>MANN2710</b>   |
| EQUIV 1:                          | MBA209426/KGP9276 |
| EQUIV 2:                          |                   |
| OEM:                              | 21010-7Y025/JK00A |
|                                   |                   |

BOMBA AGUA (ALTIMA-MAXIMA 3.5L/MURANO-QUEST 3.5L/PATHFINDER-X-TERRA 4.0L)



|   |                   |
|---|-------------------|
| <b>NS</b>                               |                   |
| <b>NP-300 (D-22) 4WD 2.5L 2008-2015</b> |                   |
| CÓDIGO:                                 | <b>MANN0700</b>   |
| EQUIV 1:                                | MBA201754/KGP1450 |
| EQUIV 2:                                |                   |
| OEM:                                    | 21010-VK525       |
|   |                   |

BOMBA AGUA DIESEL YD25DDTI (NV-350 2.5L DIESEL/CABSTAR 2.5L DIESEL)



|   |                 |
|---|-----------------|
| <b>NS</b>                               |                 |
| <b>NP-300 FRONTIER (D-23) 2016-2024</b> |                 |
| CÓDIGO:                                 | <b>MANN0710</b> |
| EQUIV 1:                                | MBA209034       |
| EQUIV 2:                                |                 |
| OEM:                                    | 21010-4JM0A     |
|   |                 |

BOMBA AGUA 2/4WD (2.5L GASOLINA) (SENCILLA/DOBLE CABINA)

# BOMBA DE AGUA



**NS**

## NV-350 2.5L GAS 2013-2022

|          |                   |
|----------|-------------------|
| CÓDIGO:  | <b>MANN0410</b>   |
| EQUIV 1: | MBA201820/KGP1449 |
| EQUIV 2: |                   |
| OEM:     | 21010-EA010       |



BOMBA AGUA QR25DE (URVAN 2.5L GAS 07-12)



**NS**

## PLATINA 1.6L 2002-2010

|          |                   |
|----------|-------------------|
| CÓDIGO:  | <b>MANN0300</b>   |
| EQUIV 1: | MBA201641/KGP1641 |
| EQUIV 2: |                   |
| OEM:     | 21010-00QAA       |



BOMBA AGUA (APRIO/CLIO-MEGANE 1.6L/LOGAN/KANGOO/SANDERO 10-11/STEPWAY 10-20)



**NS**

## SENTRA B-15 1.8L 2001-2006

|          |                   |
|----------|-------------------|
| CÓDIGO:  | <b>MANN1300</b>   |
| EQUIV 1: | MBA209416/KGP9349 |
| EQUIV 2: |                   |
| OEM:     | 21010-F4600       |



BOMBA AGUA QG18DE (ALMERA 1.8L 01-06/SCALA 1.6L 10-13)



**NS**

## SENTRA B-17 1.8L 2013-2020

|          |                   |
|----------|-------------------|
| CÓDIGO:  | <b>MANN1800</b>   |
| EQUIV 1: | MBA209022/KGP1916 |
| EQUIV 2: | ALTIMA 2.5L 19-22 |
| OEM:     | 21010-3RC1A/3RC2A |



BOMBA AGUA C/POLEA 16VAL MRA8DE/HR16DE (VERSA 1.6L 20-24/SENTRA B-18/KICKS/JUKE)



**NS**

## TIIDA 1.8L 2006-2017

|          |                   |
|----------|-------------------|
| CÓDIGO:  | <b>MANN1110</b>   |
| EQUIV 1: | MBA209000/KGP2118 |
| EQUIV 2: |                   |
| OEM:     | 21010-ET025       |



BOMBA AGUA MR18DE C/POLEA (SENTRA B-16 2.0L MR20DE 07-10)



**NS**

## TS-I 1.5L 1984-1987

|          |                  |
|----------|------------------|
| CÓDIGO:  | <b>MANN1500</b>  |
| EQUIV 1: | MBA202195/KGP601 |
| EQUIV 2: |                  |
| OEM:     | 21010-01M25      |



BOMBA AGUA BRIDA CHICA (E13/E15)



**NS**

## TS-II 1.6L 1988-1991

|          |                 |
|----------|-----------------|
| CÓDIGO:  | <b>MANN0500</b> |
| EQUIV 1: |                 |
| EQUIV 2: |                 |
| OEM:     | 21010-50A28     |



BOMBA AGUA BRIDA GRANDE 8VAL E16



**NS**

## TS-III 1.6L 1995-2017

|          |                  |
|----------|------------------|
| CÓDIGO:  | <b>MANN0100</b>  |
| EQUIV 1: | MBA202198/KGP862 |
| EQUIV 2: |                  |
| OEM:     | 21010-F4300      |



BOMBA AGUA 16VAL (SENTRA B-14/TSUBAME 92-04/LUCINO 96-00)



|                                  |                  |
|----------------------------------|------------------|
| <b>NS</b>                        |                  |
| <b>TS-III 2.0L GSR 1992-1996</b> |                  |
| CÓDIGO:                          | <b>MANN0110</b>  |
| EQUIV 1:                         | MBA202379/KGP861 |
| EQUIV 2:                         |                  |
| OEM:                             | 21010-53J00      |
|                                  |                  |

BOMBA AGUA 16VAL (B-14 GSR 96-00/LUCINO GSR 96-00/TS-II GSR 88-91)



|                                    |                 |
|------------------------------------|-----------------|
| <b>NS</b>                          |                 |
| <b>URVAN 3.0L DIESEL 2007-2012</b> |                 |
| CÓDIGO:                            | <b>MANN0400</b> |
| EQUIV 1:                           |                 |
| EQUIV 2:                           |                 |
| OEM:                               | 21010-2W225     |
|                                    |                 |

BOMBA AGUA C/FAN CLUTCH C/POLEA ZD30DD 10 ORIFICIOS



|                                    |                 |
|------------------------------------|-----------------|
| <b>NS</b>                          |                 |
| <b>URVAN 3.0L DIESEL 2007-2012</b> |                 |
| CÓDIGO:                            | <b>MANN0420</b> |
| EQUIV 1:                           | MBA209012       |
| EQUIV 2:                           |                 |
| OEM:                               | B1010-VZ20A     |
|                                    |                 |

BOMBA AGUA ZD30DD 9 ORIFICIOS



|                             |                   |
|-----------------------------|-------------------|
| <b>NS</b>                   |                   |
| <b>VERSA 1.6L 2012-2019</b> |                   |
| CÓDIGO:                     | <b>MANN0900</b>   |
| EQUIV 1:                    | MBA209013/KGP2373 |
| EQUIV 2:                    |                   |
| OEM:                        | 21010-EE025       |
|                             |                   |

BOMBA AGUA HR16DE (V-DRIVE/MARCH 11-24/NOTE 14-19/TIIDA 1.6L/ CUBE 09-14)



|                               |                   |
|-------------------------------|-------------------|
| <b>NS</b>                     |                   |
| <b>X-TRAIL 2.5L 2001-2014</b> |                   |
| CÓDIGO:                       | <b>MANN2200</b>   |
| EQUIV 1:                      | MBA209427/KGP9350 |
| EQUIV 2:                      |                   |
| OEM:                          | 21010-6N266       |
|                               |                   |

BOMBA AGUA C/POLEA (SENTRA B-16 2.5L/Frontier 2.5L/ROGUE 2.5L/ ALTIMA 2.5L)



|                              |                   |
|------------------------------|-------------------|
| <b>PG</b>                    |                   |
| <b>PG-206 1.4L 1999-2009</b> |                   |
| CÓDIGO:                      | <b>MANP0110</b>   |
| EQUIV 1:                     | MBA212481/KGP1653 |
| EQUIV 2:                     |                   |
| OEM:                         | 1201-58/E4        |
|                              |                   |

BOMBA AGUA 20DIENTES



|                              |                   |
|------------------------------|-------------------|
| <b>PG</b>                    |                   |
| <b>PG-206 1.6L 1999-2009</b> |                   |
| CÓDIGO:                      | <b>MANP0100</b>   |
| EQUIV 1:                     | MBA212482/KGP1652 |
| EQUIV 2:                     |                   |
| OEM:                         | 1201-E5/A2        |
|                              |                   |

BOMBA AGUA 19DIENTES (PARTNER 04-12/GRAND RAID 07-12)

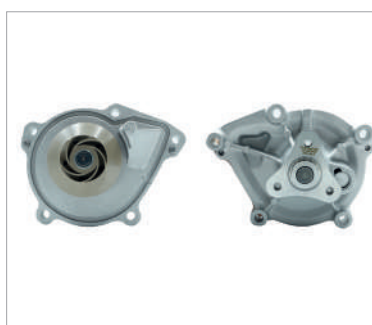

|                                 |                   |
|---------------------------------|-------------------|
| <b>PG</b>                       |                   |
| <b>PG-207 CC 1.6L 2008-2012</b> |                   |
| CÓDIGO:                         | <b>MANP0500</b>   |
| EQUIV 1:                        | MBA212149/KGP2149 |
| EQUIV 2:                        |                   |
| OEM:                            | 1201-H8           |
|                                 |                   |

BOMBA AGUA (PG-208 1.6L 14-15/PG-308 1.6L 09-14/PG-3008 1.6L 10-13)

# BOMBA DE AGUA



**RT**

## MEGANE 2.0L 2001-2004

|          |                 |
|----------|-----------------|
| CÓDIGO:  | <b>MANR0310</b> |
| EQUIV 1: | MBA23850/KGP676 |
| EQUIV 2: |                 |
| OEM:     | 77014-66578     |



BOMBA AGUA (SCENIC 2.0L 01-04/CLIO 2.0L 02-06)



**RT**

## MEGANE 2.0L 2005-2010

|          |                         |
|----------|-------------------------|
| CÓDIGO:  | <b>MANR0300</b>         |
| EQUIV 1: | MBA231668/KGP1650       |
| EQUIV 2: |                         |
| OEM:     | 77014-72182/77001-11675 |



BOMBA AGUA (DUSTER-CAPTUR-OROCH-CLIO-SCENIC-LAGUNA 2.0L/TRAFIC 1.9L)



**SZ**

## SX-4 2.0L 2007-2010

|          |                 |
|----------|-----------------|
| CÓDIGO:  | <b>MANY0500</b> |
| EQUIV 1: | KGP9231         |
| EQUIV 2: |                 |
| OEM:     | 91174494        |



BOMBA AGUA J20B (AERIO 2.0L/TRACKER 2.0L)



**SZ**

## SX-4 2.0L 2011-2014

|          |                   |
|----------|-------------------|
| CÓDIGO:  | <b>MANY0510</b>   |
| EQUIV 1: | MBA312495/KGP2465 |
| EQUIV 2: |                   |
| OEM:     | 17400-78890/91    |



BOMBA AGUA C/POLEA J20B (GRAND VITARA 2.4L 06-15/KIZASHI 2.4L 10-16)



**TY**

## AVANZA 1.5L 2016-2021

|          |                 |
|----------|-----------------|
| CÓDIGO:  | <b>MANT2000</b> |
| EQUIV 1: |                 |
| EQUIV 2: |                 |
| OEM:     | 16100-09770     |



BOMBA AGUA 2NR-FE (YARIS 1.5L 16-22)



**TY**

## COROLLA 1.8L 1998-2008

|          |                   |
|----------|-------------------|
| CÓDIGO:  | <b>MANT0210</b>   |
| EQUIV 1: | MBA279173/KGP9173 |
| EQUIV 2: |                   |
| OEM:     | 16100-09080       |



BOMBA AGUA C/POLEA (MATRIX 1.8L 03-08)



**TY**

## COROLLA 2.4L 2009-2013

|          |                 |
|----------|-----------------|
| CÓDIGO:  | <b>MANT0200</b> |
| EQUIV 1: | MBA279322       |
| EQUIV 2: |                 |
| OEM:     | 16100-0H010     |



BOMBA AGUA (RAV-4 2.0L-2.4L/CAMRY 2.4L/MATRIX 2.4L/HIGHLANDER 2.4L)



**TY**

## HIACE 2.7L 2005-2019

|          |                    |
|----------|--------------------|
| CÓDIGO:  | <b>MANT0400</b>    |
| EQUIV 1: | MBA272470/KGP-9150 |
| EQUIV 2: |                    |
| OEM:     | 16100-09460/79445  |



BOMBA AGUA 2TRFE (HILUX 06-15/4RUNNER 96-02 2010/TACOMA 95-15/HIGHLANDER/T100)

# BOMBA DE AGUA



**TY**

## TACOMA 3.4L 1995-2004

|          |                 |
|----------|-----------------|
| CÓDIGO:  | <b>MANT1600</b> |
| EQUIV 1: | KGP9152         |
| EQUIV 2: |                 |
| OEM:     | 16100-69398     |



BOMBA AGUA (4RUNNER 3.4L 96-02/T100 3.4L 93-98)



**TY**

## YARIS 1.5L 2006-2015

|          |                   |
|----------|-------------------|
| CÓDIGO:  | <b>MANT0300</b>   |
| EQUIV 1: | MBA279187/KGP1651 |
| EQUIV 2: |                   |
| OEM:     | 16100-29155/6     |



BOMBA AGUA 1NZFE



**VK**

## BORA 2.5L GAS 2006-2010

|          |                   |
|----------|-------------------|
| CÓDIGO:  | <b>MANV0400</b>   |
| EQUIV 1: | MBA282067/KGP2067 |
| EQUIV 2: |                   |
| OEM:     | 07K-121-011B      |



BOMBA AGUA C/POLEA (JETTA A6 2.5L/BEETLE 2.5L 06-11/PASSAT 2.5L 12-13)



**VK**

## EUROVAN 1.9L TDI DIESEL 2005-2010

|          |                   |
|----------|-------------------|
| CÓDIGO:  | <b>MANV1110</b>   |
| EQUIV 1: | MBA289002/KGP9250 |
| EQUIV 2: |                   |
| OEM:     | 045-121-011FX     |



BOMBA AGUA (BORA 1.9L TDI/JETTA A4 TDI/BEETLE 1.9L TDI)



**VK**

## EUROVAN 2.5L GASOLINA 2000-2004

|          |                   |
|----------|-------------------|
| CÓDIGO:  | <b>MANV1120</b>   |
| EQUIV 1: | MBA282492/KGP9076 |
| EQUIV 2: |                   |
| OEM:     | 074-121-005N      |



BOMBA AGUA (CRAFTER 2.5L DIESEL 08-23)



**VK**

## GOL 1.6L 2008-2021

|          |                   |
|----------|-------------------|
| CÓDIGO:  | <b>MANV0600</b>   |
| EQUIV 1: | MBA281682/KGP1644 |
| EQUIV 2: |                   |
| OEM:     | 030-121-005N/008D |



BOMBA AGUA 27DIENTES (POLO-LUPO 1.6L/SAVEIRO/CROSSFOX/IBIZA/ CORDOBA/SPORT VAN)



**VK**

## JETTA 2.8L VR6 1999-2002

|          |                  |
|----------|------------------|
| CÓDIGO:  | <b>MANV0110</b>  |
| EQUIV 1: | MBA282397/KGP883 |
| EQUIV 2: |                  |
| OEM:     | 021-121-004      |



BOMBA AGUA (PASSAT 2.8L V6 93-97)



**VK**

## JETTA A4 1.9L DIESEL 1999-2007

|          |                   |
|----------|-------------------|
| CÓDIGO:  | <b>MANV0100</b>   |
| EQUIV 1: | MBA289378/KGP9249 |
| EQUIV 2: |                   |
| OEM:     | 038-121-011A/AX   |



BOMBA AGUA (BORA 1.9L/BEETLE 1.9L/GOLF A4 1.9L)



# BOMBA DE AGUA



VK

JETTA A4/CLASICO 1.8L/2.0L 1999-2015

|          |                   |
|----------|-------------------|
| CÓDIGO:  | <b>MANV0120</b>   |
| EQUIV 1: | MBA282030/KGP1643 |
| EQUIV 2: |                   |
| OEM:     | 06A-121-012E      |



BOMBA AGUA (JETTA A4 TURBO/POINTER GTI/BEETLE/GOLF A4/DERBY/PASSAT/EOS)



VK

POINTER 1.8L 1998-2009

|          |                  |
|----------|------------------|
| CÓDIGO:  | <b>MANV0200</b>  |
| EQUIV 1: | MBA282190/KGP664 |
| EQUIV 2: |                  |
| OEM:     | 037-121-005C     |



BOMBA AGUA S/BASE BRIDA CHICA (JT-GF A2-A3 1.8L/DERBY 1.8L/COMBI 1.8L)



VK

POINTER 1.8L 1998-2009

|          |                 |
|----------|-----------------|
| CÓDIGO:  | <b>MANV0210</b> |
| EQUIV 1: | MBA282190BH     |
| EQUIV 2: |                 |
| OEM:     | 037-121-010C    |



BOMBA AGUA C/BASE BRIDA CHICA (JT-GF A2-A3 1.8L/DERBY 1.8L/COMBI 1.8L)



VK

VENTO 1.6L DIESEL 2014-2019

|          |                   |
|----------|-------------------|
| CÓDIGO:  | <b>MANV0710</b>   |
| EQUIV 1: | MBA282256/KGP1909 |
| EQUIV 2: |                   |
| OEM:     | 03L-121-011J      |



BOMBA AGUA CLNA (AMAROK-CRAFTER 2.0L/TRANSPORTER 2.0L 11-21/PASSAT 2.0L 12-15)



VK

VENTO 1.6L GAS 2014-2022

|          |                   |
|----------|-------------------|
| CÓDIGO:  | <b>MANV0700</b>   |
| EQUIV 1: | MBA289028/KGP1915 |
| EQUIV 2: |                   |
| OEM:     | 03C-121-008J      |



BOMBA AGUA CLSA/CLPA (POLO 15-19/IBIZA 10-17/TOLEDO 13-19/AD A1 10-15)



VK

VIRTUS 1.6L 2020-2024

|          |                 |
|----------|-----------------|
| CÓDIGO:  | <b>MANV0900</b> |
| EQUIV 1: | MBA289042BH     |
| EQUIV 2: |                 |
| OEM:     | 04E-121-600CG   |



BOMBA AGUA COMPLETA (TIGUAN 1.4L 13-22/UP 1.0L 16-19/POLO 1.2L TSI 13-19)



|                            |                 |
|----------------------------|-----------------|
| <b>CV</b>                  |                 |
| <b>AVEO 1.5L 2018-2023</b> |                 |
| CÓDIGO:                    | <b>MMNC9910</b> |
| EQUIV 1:                   |                 |
| EQUIV 2:                   |                 |
| OEM:                       | 26203418        |
|                            |                 |

MOTOVENTILADOR COMPLETO C/S AIRE C/TOLVA C/RES 3PIN



|                            |                 |
|----------------------------|-----------------|
| <b>CV</b>                  |                 |
| <b>AVEO 1.5L 2018-2023</b> |                 |
| CÓDIGO:                    | <b>MMNC9911</b> |
| EQUIV 1:                   |                 |
| EQUIV 2:                   |                 |
| OEM:                       | 90923644        |
|                            |                 |

MOTOVENTILADOR C/S AIRE S/TOLVA C/RES 3PIN (MOTOR/ASPA)



|                            |                 |
|----------------------------|-----------------|
| <b>CV</b>                  |                 |
| <b>AVEO 1.6L 2007-2009</b> |                 |
| CÓDIGO:                    | <b>MMNC9951</b> |
| EQUIV 1:                   |                 |
| EQUIV 2:                   |                 |
| OEM:                       | 96536520        |
|                            |                 |

MOTOVENTILADOR COMPLETO P/AIRE ACONDICIONADO C/TOLVA S/RES 2PIN (PT G3 06-09)



|                            |                 |
|----------------------------|-----------------|
| <b>CV</b>                  |                 |
| <b>AVEO 1.6L 2007-2009</b> |                 |
| CÓDIGO:                    | <b>MMNC9952</b> |
| EQUIV 1:                   |                 |
| EQUIV 2:                   |                 |
| OEM:                       | 96536521        |
|                            |                 |

MOTOVENTILADOR COMPLETO P/RADIADOR C/TOLVA S/RES 2PIN (PT G3 06-09)

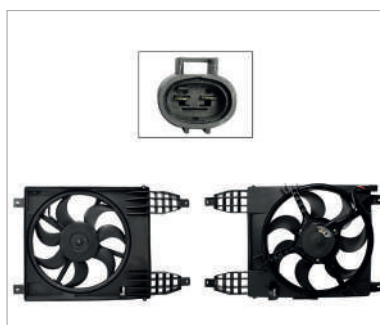

|                            |                 |
|----------------------------|-----------------|
| <b>CV</b>                  |                 |
| <b>AVEO 1.6L 2010-2017</b> |                 |
| CÓDIGO:                    | <b>MMNC9902</b> |
| EQUIV 1:                   |                 |
| EQUIV 2:                   |                 |
| OEM:                       | 96962096        |
|                            |                 |

MOTOVENTILADOR COMPLETO C/S AIRE C/TOLVA S/RES 2PIN



|                            |                 |
|----------------------------|-----------------|
| <b>CV</b>                  |                 |
| <b>BEAT 1.2L 2018-2021</b> |                 |
| CÓDIGO:                    | <b>MMNC1152</b> |
| EQUIV 1:                   |                 |
| EQUIV 2:                   |                 |
| OEM:                       |                 |
|                            |                 |

MOTOVENTILADOR C/S AIRE S/TOLVA EMBRA 2PIN (SPARK 11-17) (SE-DAN/H-BACK)



|   |                 |
|---|-----------------|
| <b>CV</b>                               |                 |
| <b>CAPTIVA 2.4L/3.0L/3.6L 2008-2010</b> |                 |
| CÓDIGO:                                 | <b>MMNC7200</b> |
| EQUIV 1:                                |                 |
| EQUIV 2:                                |                 |
| OEM:                                    | 95297048        |
|   |                 |

MOTOVENTILADOR COMPLETO C/S AIRE C/TOLVA S/RES 2PIN (2ASPAS)



|   |                 |
|---|-----------------|
| <b>CV</b>                               |                 |
| <b>CAPTIVA 2.4L/3.0L/3.6L 2011-2015</b> |                 |
| CÓDIGO:                                 | <b>MMNC7210</b> |
| EQUIV 1:                                |                 |
| EQUIV 2:                                |                 |
| OEM:                                    | 96629064        |
|   |                 |

MOTOVENTILADOR COMPLETO C/S AIRE C/TOLVA S/RES EMBRA 2PIN (2ASPAS)



|                                  |                 |
|----------------------------------|-----------------|
| <b>CV</b>                        |                 |
| <b>CHEVY 1.4L/1.6L 1994-2012</b> |                 |
| CÓDIGO:                          | <b>MMNC0100</b> |
| EQUIV 1:                         |                 |
| EQUIV 2:                         |                 |
| OEM:                             |                 |
|                                  |                 |

MOTOR DE VENTILADOR SOLO S/AIRE 2PIN (C-2/C-3)



|                                  |                   |
|----------------------------------|-------------------|
| <b>CV</b>                        |                   |
| <b>CHEVY 1.4L/1.6L 1994-2012</b> |                   |
| CÓDIGO:                          | <b>MMNC0101</b>   |
| EQUIV 1:                         |                   |
| EQUIV 2:                         |                   |
| OEM:                             | 22061461/93230490 |
|                                  |                   |

MOTOVENTILADOR S/AIRE S/TOLVA 2PIN (C-2/C-3) (MOTOR/ASPA)

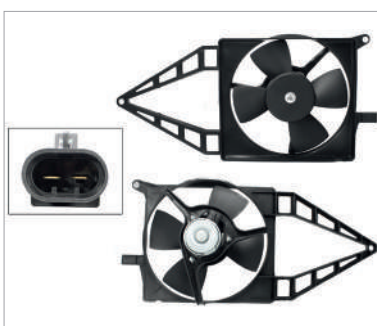

|                                  |                 |
|----------------------------------|-----------------|
| <b>CV</b>                        |                 |
| <b>CHEVY 1.4L/1.6L 1994-2012</b> |                 |
| CÓDIGO:                          | <b>MMNC0102</b> |
| EQUIV 1:                         |                 |
| EQUIV 2:                         |                 |
| OEM:                             | 22061461/A      |
|                                  |                 |

MOTOVENTILADOR COMPLETO S/AIRE C/TOLVA S/RES 2PIN (C-2/C-3)



|                                  |                 |
|----------------------------------|-----------------|
| <b>CV</b>                        |                 |
| <b>CHEVY 1.4L/1.6L 1994-2012</b> |                 |
| CÓDIGO:                          | <b>MMNC0150</b> |
| EQUIV 1:                         |                 |
| EQUIV 2:                         |                 |
| OEM:                             |                 |
|                                  |                 |

MOTOR DE VENTILADOR SOLO C/AIRE 2PIN (C-2/C-3)



|                                  |                 |
|----------------------------------|-----------------|
| <b>CV</b>                        |                 |
| <b>CHEVY 1.4L/1.6L 1994-2012</b> |                 |
| CÓDIGO:                          | <b>MMNC0151</b> |
| EQUIV 1:                         |                 |
| EQUIV 2:                         |                 |
| OEM:                             | 93294288        |
|                                  |                 |

MOTOVENTILADOR C/AIRE S/TOLVA 2PIN (C-2/C-3) (MOTOR/ASPA)



|                                  |                 |
|----------------------------------|-----------------|
| <b>CV</b>                        |                 |
| <b>CHEVY 1.4L/1.6L 1994-2012</b> |                 |
| CÓDIGO:                          | <b>MMNC0152</b> |
| EQUIV 1:                         |                 |
| EQUIV 2:                         |                 |
| OEM:                             | 93294288/A      |
|                                  |                 |

MOTOVENTILADOR COMPLETO C/AIRE C/TOLVA S/RES 2PIN (C-2/C-3)



|                                  |                 |
|----------------------------------|-----------------|
| <b>CV</b>                        |                 |
| <b>CORSA 1.4L/1.8L 2003-2008</b> |                 |
| CÓDIGO:                          | <b>MMNC0201</b> |
| EQUIV 1:                         |                 |
| EQUIV 2:                         |                 |
| OEM:                             | 1341331         |
|                                  |                 |

MOTOVENTILADOR S/AIRE S/TOLVA 2PIN (MOTOR/ASPA)



|                                  |                 |
|----------------------------------|-----------------|
| <b>CV</b>                        |                 |
| <b>CORSA 1.4L/1.8L 2003-2008</b> |                 |
| CÓDIGO:                          | <b>MMNC0202</b> |
| EQUIV 1:                         |                 |
| EQUIV 2:                         |                 |
| OEM:                             | 24445175        |
|                                  |                 |

MOTOVENTILADOR COMPLETO S/AIRE C/TOLVA S/RESISTENCIA 2PIN



|                                  |                  |
|----------------------------------|------------------|
| <b>CV</b>                        |                  |
| <b>CORSA 1.4L/1.8L 2003-2008</b> |                  |
| CÓDIGO:                          | <b>MMNC0251</b>  |
| EQUIV 1:                         |                  |
| EQUIV 2:                         |                  |
| OEM:                             | 24402524/1314443 |
|                                  |                  |

MOTOVENTILADOR C/AIRE S/TOLVA C/RES 3PIN (TORNADO 04-11) (MOTOR/ASPA)



|                                  |                 |
|----------------------------------|-----------------|
| <b>CV</b>                        |                 |
| <b>CORSA 1.4L/1.8L 2003-2008</b> |                 |
| CÓDIGO:                          | <b>MMNC0252</b> |
| EQUIV 1:                         |                 |
| EQUIV 2:                         |                 |
| OEM:                             | 24445173        |
|                                  |                 |

MOTOVENTILADOR COMPLETO C/AIRE C/TOLVA C/RES 3PIN (TORNADO 04-11)



|                                  |                 |
|----------------------------------|-----------------|
| <b>CV</b>                        |                 |
| <b>CRUZE 1.4L/1.8L 2010-2015</b> |                 |
| CÓDIGO:                          | <b>MMNC1000</b> |
| EQUIV 1:                         |                 |
| EQUIV 2:                         |                 |
| OEM:                             | 13267630        |
|                                  |                 |

MOTOVENTILADOR COMPLETO C/AIRE C/TOLVA CORTA C/RES 4PIN



|                                  |                 |
|----------------------------------|-----------------|
| <b>CV</b>                        |                 |
| <b>CRUZE 1.4L/1.8L 2010-2018</b> |                 |
| CÓDIGO:                          | <b>MMNC1010</b> |
| EQUIV 1:                         |                 |
| EQUIV 2:                         |                 |
| OEM:                             | 13372154        |
|                                  |                 |

MOTOVENTILADOR COMPLETO C/AIRE C/TOLVA LARGA C/RES 4PIN

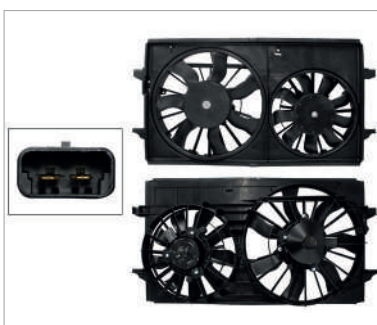

|                              |                 |
|------------------------------|-----------------|
| <b>CV</b>                    |                 |
| <b>MALIBU 2.4L 2004-2012</b> |                 |
| CÓDIGO:                      | <b>MMNC3000</b> |
| EQUIV 1:                     |                 |
| EQUIV 2:                     |                 |
| OEM:                         | 15788745        |
|                              |                 |

MOTOVENTILADOR COMPLETO C/AIRE C/TOLVA S/RES 2PIN (G6 2.4L 05-10) (2ASPAS)



|                                |                 |
|--------------------------------|-----------------|
| <b>CV</b>                      |                 |
| <b>MATIZ G1 1.0L 2003-2005</b> |                 |
| CÓDIGO:                        | <b>MMNG0100</b> |
| EQUIV 1:                       |                 |
| EQUIV 2:                       |                 |
| OEM:                           | 96611266        |
|                                |                 |

MOTOVENTILADOR COMPLETO S/AIRE C/TOLVA S/RES EMBRA 2PIN



|                                |                 |
|--------------------------------|-----------------|
| <b>CV</b>                      |                 |
| <b>MATIZ G2 1.0L 2006-2015</b> |                 |
| CÓDIGO:                        | <b>MMNG0102</b> |
| EQUIV 1:                       |                 |
| EQUIV 2:                       |                 |
| OEM:                           | 96314167        |
|                                |                 |

MOTOVENTILADOR COMPLETO S/AIRE C/TOLVA S/RES EMBRA 2PIN



|                                 |                 |
|---------------------------------|-----------------|
| <b>CV</b>                       |                 |
| <b>ONIX 1.0L/1.2L 2020-2024</b> |                 |
| CÓDIGO:                         | <b>MMNC0500</b> |
| EQUIV 1:                        |                 |
| EQUIV 2:                        |                 |
| OEM:                            | 26317588        |
|                                 |                 |

MOTOVENTILADOR COMPLETO C/S AIRE C/TOLVA C/RES 4PIN



|                                 |                 |
|---------------------------------|-----------------|
| <b>CV</b>                       |                 |
| <b>ONIX 1.0L/1.2L 2020-2024</b> |                 |
| CÓDIGO:                         | <b>MMNC0501</b> |
| EQUIV 1:                        |                 |
| EQUIV 2:                        |                 |
| OEM:                            | 26287392        |
|                                 |                 |

MOTOVENTILADOR C/S AIRE S/TOLVA C/RES 4PIN (MOTOR/ASPA)



|                             |                 |
|-----------------------------|-----------------|
| <b>CV</b>                   |                 |
| <b>OPTRA 2.0L 2006-2010</b> |                 |
| CÓDIGO:                     | <b>MMNC1701</b> |
| EQUIV 1:                    |                 |
| EQUIV 2:                    |                 |
| OEM:                        | 96553241        |
|                             |                 |

MOTOVENTILADOR COMPLETO P/AIRE ACONDICIONADO C/TOLVA S/RES 2PIN



|                             |                 |
|-----------------------------|-----------------|
| <b>CV</b>                   |                 |
| <b>OPTRA 2.0L 2006-2010</b> |                 |
| CÓDIGO:                     | <b>MMNC1702</b> |
| EQUIV 1:                    |                 |
| EQUIV 2:                    |                 |
| OEM:                        | 96553242        |
|                             |                 |

MOTOVENTILADOR COMPLETO P/RADIADOR C/TOLVA S/RES 2PIN



|                                     |                 |
|-------------------------------------|-----------------|
| <b>CV</b>                           |                 |
| <b>S-10 MAX 2.0L/2.4L 2022-2024</b> |                 |
| CÓDIGO:                             | <b>MMNC1800</b> |
| EQUIV 1:                            |                 |
| EQUIV 2:                            |                 |
| OEM:                                | 19436667        |
|                                     |                 |

MOTOVENTILADOR COMPLETO C/AIRE C/TOLVA C/RES 4PIN



|                             |                 |
|-----------------------------|-----------------|
| <b>CV</b>                   |                 |
| <b>SONIC 1.6L 2013-2018</b> |                 |
| CÓDIGO:                     | <b>MMNC0900</b> |
| EQUIV 1:                    |                 |
| EQUIV 2:                    |                 |
| OEM:                        | 94509632        |
|                             |                 |

MOTOVENTILADOR COMPLETO C/S AIRE C/TOLVA C/RES 3PIN



|                             |                 |
|-----------------------------|-----------------|
| <b>CV</b>                   |                 |
| <b>SONIC 1.6L 2013-2018</b> |                 |
| CÓDIGO:                     | <b>MMNC0901</b> |
| EQUIV 1:                    |                 |
| EQUIV 2:                    |                 |
| OEM:                        | 95352379        |
|                             |                 |

MOTOVENTILADOR C/S AIRE S/TOLVA C/RES 3PIN (MOTOR/ASPA)



|                             |                   |
|-----------------------------|-------------------|
| <b>CV</b>                   |                   |
| <b>SPARK 1.2L 2011-2017</b> |                   |
| CÓDIGO:                     | <b>MMNC0800</b>   |
| EQUIV 1:                    |                   |
| EQUIV 2:                    |                   |
| OEM:                        | 95978940/42564588 |
|                             |                   |

MOTOVENTILADOR COMPLETO C/S AIRE C/TOLVA S/RES EMBRA 2PIN (BEAT 1.2L 18-21)



|                                |                 |
|--------------------------------|-----------------|
| <b>CV</b>                      |                 |
| <b>SPARK NG 1.4L 2016-2021</b> |                 |
| CÓDIGO:                        | <b>MMNC0820</b> |
| EQUIV 1:                       |                 |
| EQUIV 2:                       |                 |
| OEM:                           | 42426778        |
|                                |                 |

MOTOVENTILADOR COMPLETO C/S AIRE C/TOLVA S/RES 2PIN (NUEVA LINEA)



|                            |                   |
|----------------------------|-------------------|
| <b>CV</b>                  |                   |
| <b>TRAX 1.8L 2013-2020</b> |                   |
| CÓDIGO:                    | <b>MMNC0700</b>   |
| EQUIV 1:                   |                   |
| EQUIV 2:                   |                   |
| OEM:                       | 94509632/95465725 |
|                            |                   |

MOTOVENTILADOR COMPLETO C/AIRE C/TOLVA C/RES 3PIN



|                            |                 |
|----------------------------|-----------------|
| <b>CV</b>                  |                 |
| <b>TRAX 1.8L 2013-2020</b> |                 |
| CÓDIGO:                    | <b>MMNC0701</b> |
| EQUIV 1:                   |                 |
| EQUIV 2:                   |                 |
| OEM:                       | 52096865        |
|                            |                 |

MOTOVENTILADOR C/AIRE S/TOLVA C/RES 3PIN (MOTOR/ASPA)



|                            |                 |
|----------------------------|-----------------|
| <b>DG</b>                  |                 |
| <b>ATOS 1.0L 2000-2004</b> |                 |
| CÓDIGO:                    | <b>MMNK0101</b> |
| EQUIV 1:                   |                 |
| EQUIV 2:                   |                 |
| OEM:                       | 25350-05500     |
|                            |                 |

MOTOVENTILADOR COMPLETO S/AIRE C/TOLVA S/RES EMBRA 2PIN



|                            |                 |
|----------------------------|-----------------|
| <b>DG</b>                  |                 |
| <b>ATOS 1.1L 2005-2012</b> |                 |
| CÓDIGO:                    | <b>MMNK0111</b> |
| EQUIV 1:                   |                 |
| EQUIV 2:                   |                 |
| OEM:                       | 25380-05500     |
|                            |                 |

MOTOVENTILADOR COMPLETO S/AIRE C/TOLVA S/RES 2PIN



|                                     |                 |
|-------------------------------------|-----------------|
| <b>DG</b>                           |                 |
| <b>ATTITUDE 1.4L/1.6L 2006-2011</b> |                 |
| CÓDIGO:                             | <b>MMNK1101</b> |
| EQUIV 1:                            |                 |
| EQUIV 2:                            |                 |
| OEM:                                | 97730-1E100     |
|                                     |                 |

MOTOVENTILADOR COMPLETO P/AIRE ACONDICIONADO C/TOLVA S/RES 2PIN



|                                     |                 |
|-------------------------------------|-----------------|
| <b>DG</b>                           |                 |
| <b>ATTITUDE 1.4L/1.6L 2006-2011</b> |                 |
| CÓDIGO:                             | <b>MMNK1102</b> |
| EQUIV 1:                            |                 |
| EQUIV 2:                            |                 |
| OEM:                                | 25380-1E100     |
|                                     |                 |

MOTOVENTILADOR COMPLETO P/RADIADOR C/TOLVA S/RES 2PIN

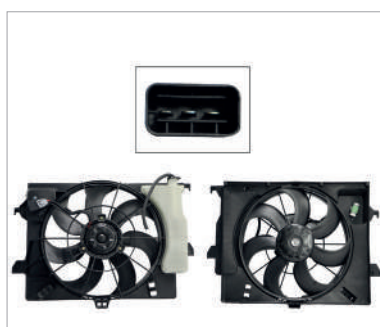

|                                |                 |
|--------------------------------|-----------------|
| <b>DG</b>                      |                 |
| <b>ATTITUDE 1.6L 2012-2014</b> |                 |
| CÓDIGO:                        | <b>MMNK1100</b> |
| EQUIV 1:                       |                 |
| EQUIV 2:                       |                 |
| OEM:                           | 25380-1R050     |
|                                |                 |

MOTOVENTILADOR COMPLETO C/AIRE C/TOLVA C/RES 3PIN (KA RIO 16-17)

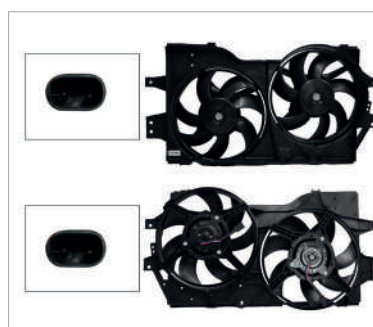

|                                  |                   |
|----------------------------------|-------------------|
| <b>DG</b>                        |                   |
| <b>CARAVAN/VOYAGER 1996-2000</b> |                   |
| CÓDIGO:                          | <b>MMRK0700</b>   |
| EQUIV 1:                         |                   |
| EQUIV 2:                         |                   |
| OEM:                             | 4364910/4682624AB |
|                                  |                   |

MOTOVENTILADOR COMPLETO C/AIRE C/TOLVA S/RES 2PIN (TOWN & COUNTRY) (2ASPAS)



|                                  |                 |
|----------------------------------|-----------------|
| <b>DG</b>                        |                 |
| <b>CARAVAN/VOYAGER 2005-2007</b> |                 |
| CÓDIGO:                          | <b>MMNK0710</b> |
| EQUIV 1:                         |                 |
| EQUIV 2:                         |                 |
| OEM:                             | 4677695AB       |
|                                  |                 |

MOTOVENTILADOR COMPLETO C/AIRE C/TOLVA S/RES 2PIN (TOWN & COUNTRY) (2ASPAS)



|   |                 |
|---|-----------------|
| <b>DG</b>                                 |                 |
| <b>G.CARAVAN 3.3L/3.8L/4.0L 2008-2018</b> |                 |
| CÓDIGO:                                   | <b>MMNK0720</b> |
| EQUIV 1:                                  |                 |
| EQUIV 2:                                  |                 |
| OEM:                                      | 5058674AA       |
|   |                 |

MOTOVENTI COMPLETO C/AIRE C/TOLVA C/RES 2PIN (T&COUNTRY/VOYAGER/VW ROUTAN) 1ASPA



|                            |                 |
|----------------------------|-----------------|
| <b>DG</b>                  |                 |
| <b>I-10 1.1L 2011-2014</b> |                 |
| CÓDIGO:                    | <b>MMNK0800</b> |
| EQUIV 1:                   |                 |
| EQUIV 2:                   |                 |
| OEM:                       | 25380-0X550     |
|                            |                 |

MOTOVENTILADOR COMPLETO C/S AIRE C/TOLVA S/RES 2PIN



|   |                 |
|---|-----------------|
| <b>DG</b>                               |                 |
| <b>JOURNEY 2.4L/3.5L/3.6L 2009-2020</b> |                 |
| CÓDIGO:                                 | <b>MMNK8100</b> |
| EQUIV 1:                                |                 |
| EQUIV 2:                                |                 |
| OEM:                                    | 68057-238AA     |
|   |                 |

MOTOVENTILADOR COMPLETO C/AIRE C/TOLVA S/RES 2PIN



|   |                 |
|---|-----------------|
| <b>DG</b>                               |                 |
| <b>JOURNEY 2.4L/3.5L/3.6L 2009-2020</b> |                 |
| CÓDIGO:                                 | <b>MMRK8100</b> |
| EQUIV 1:                                |                 |
| EQUIV 2:                                |                 |
| OEM:                                    | 68057-238AA     |
|   |                 |

MOTOVENTILADOR COMPLETO C/AIRE C/TOLVA S/RES 2PIN



|                               |                 |
|-------------------------------|-----------------|
| <b>DG</b>                     |                 |
| <b>LIBERTY 3.7L 2008-2013</b> |                 |
| CÓDIGO:                       | <b>MMNK3600</b> |
| EQUIV 1:                      |                 |
| EQUIV 2:                      |                 |
| OEM:                          | 68033-228AA     |
|                               |                 |

MOTOVENTILADOR COMPLETO C/AIRE C/RES 3PIN



|                                  |                 |
|----------------------------------|-----------------|
| <b>DG</b>                        |                 |
| <b>VERNA 1.5L/1.6L 2004-2006</b> |                 |
| CÓDIGO:                          | <b>MMNK2501</b> |
| EQUIV 1:                         |                 |
| EQUIV 2:                         |                 |
| OEM:                             | 25380-25000     |
|                                  |                 |

MOTOVENTILADOR COMPLETO S/AIRE C/TOLVA 2PIN

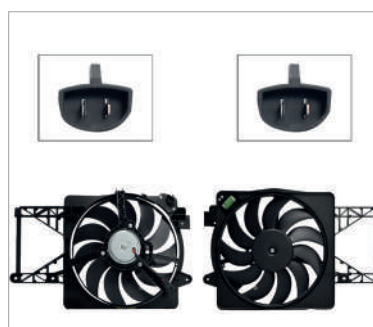

|                               |                 |
|-------------------------------|-----------------|
| <b>FD</b>                     |                 |
| <b>COURIER 1.6L 2001-2010</b> |                 |
| CÓDIGO:                       | <b>MMNF1200</b> |
| EQUIV 1:                      |                 |
| EQUIV 2:                      |                 |
| OEM:                          | XS6H-8C607PC    |
|                               |                 |

MOTOVENTILADOR COMPLETO C/AIRE C/TOLVA C/RES 2PIN (KA 01-08/ IKON 01-07)



**FD**

**FIESTA FIRST 1.6L 2003-2010**

|          |                 |
|----------|-----------------|
| CÓDIGO:  | <b>MMNF0200</b> |
| EQUIV 1: |                 |
| EQUIV 2: |                 |
| OEM:     | 2S65-8C607EA    |



MOTOR DE VENTILADOR SOLO C/AIRE 2PIN (ECOSPORT 04-12)



**FD**

**FIESTA FIRST 1.6L 2003-2010**

|          |                 |
|----------|-----------------|
| CÓDIGO:  | <b>MMNF0201</b> |
| EQUIV 1: |                 |
| EQUIV 2: |                 |
| OEM:     | 2S65-8C607EA    |



MOTOVENTILADOR COMPLETO C/AIRE C/TOLVA S/RES 2PIN (ECOSPORT 04-12)

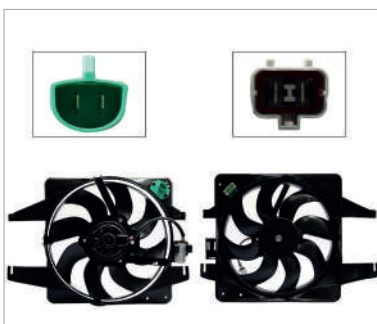

**FD**

**FIESTA IKON 1.3L/1.4L/1.6L 1998-2010**

|          |                 |
|----------|-----------------|
| CÓDIGO:  | <b>MMNF0300</b> |
| EQUIV 1: |                 |
| EQUIV 2: |                 |
| OEM:     | 3N21-8C607AC    |



MOTOVENTILADOR COMPLETO P/RADIADOR C/TOLVA S/RES 2PIN

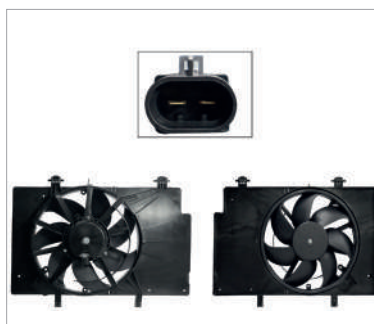

**FD**

**FIGO 1.5L 2016-2022**

|          |                          |
|----------|--------------------------|
| CÓDIGO:  | <b>MMNF0700</b>          |
| EQUIV 1: |                          |
| EQUIV 2: |                          |
| OEM:     | C1B1-8C607FA/BE8Z-8C607A |



MOTOVENTILADOR COMPLETO S/AIRE C/TOLVA S/RES 2PIN (FIESTA 11-19/ECOSPORT 13-17)



**FD**

**FIGO 1.5L 2016-2022**

|          |                 |
|----------|-----------------|
| CÓDIGO:  | <b>MMNF0710</b> |
| EQUIV 1: |                 |
| EQUIV 2: |                 |
| OEM:     | ZJ36-15025      |



MOTOVENTILADOR COMPLETO C/AIRE C/TOLVA C/RES 2PIN (FIESTA 1.6L 11-19)



**HD**

**ACCORD 2.3L 1998-2002**

|          |                 |
|----------|-----------------|
| CÓDIGO:  | <b>MMNH0102</b> |
| EQUIV 1: |                 |
| EQUIV 2: |                 |
| OEM:     | 38605-PAA-A01   |



MOTOVENTILADOR COMPLETO P/AIRE ACONDICIONADO 2PIN



**HD**

**ACCORD 2.4L 2003-2007**

|          |                 |
|----------|-----------------|
| CÓDIGO:  | <b>MMNH0112</b> |
| EQUIV 1: |                 |
| EQUIV 2: |                 |
| OEM:     | 19005-PP1-003   |



MOTOVENTILADOR COMPLETO C/AIRE C/TOLVA S/RES 4PIN (2ASPAS)



**HD**

**CR-V 2.4L 2002-2006**

|          |                 |
|----------|-----------------|
| CÓDIGO:  | <b>MMNH0301</b> |
| EQUIV 1: |                 |
| EQUIV 2: |                 |
| OEM:     | 38615-PNB-003   |



MOTOVENTILADOR COMPLETO P/AIRE ACONDICIONADO C/TOLVA S/RES 2PIN (ELEMENT 2.4L)





|                            |                 |
|----------------------------|-----------------|
| <b>HD</b>                  |                 |
| <b>CR-V 2.4L 2007-2011</b> |                 |
| CÓDIGO:                    | <b>MMNH0311</b> |
| EQUIV 1:                   |                 |
| EQUIV 2:                   |                 |
| OEM:                       | 38615-RZA-A01   |
|                            |                 |

MOTOVENTILADOR COMPLETO P/AIRE ACONDICIONADO C/TOLVA S/RES 2PIN



|                            |                 |
|----------------------------|-----------------|
| <b>HD</b>                  |                 |
| <b>CR-V 2.4L 2012-2016</b> |                 |
| CÓDIGO:                    | <b>MMNH0320</b> |
| EQUIV 1:                   |                 |
| EQUIV 2:                   |                 |
| OEM:                       | 19015-R5A-A01   |
|                            |                 |

MOTOVENTILADOR COMPLETO P/RADIADOR C/TOLVA C/RES 2PIN



|                            |                 |
|----------------------------|-----------------|
| <b>HD</b>                  |                 |
| <b>CR-V 2.4L 2012-2016</b> |                 |
| CÓDIGO:                    | <b>MMNH0321</b> |
| EQUIV 1:                   |                 |
| EQUIV 2:                   |                 |
| OEM:                       | 38615-R5A-A01   |
|                            |                 |

MOTOVENTILADOR COMPLETO P/AIRE ACONDICIONADO C/TOLVA C/RES 2PIN

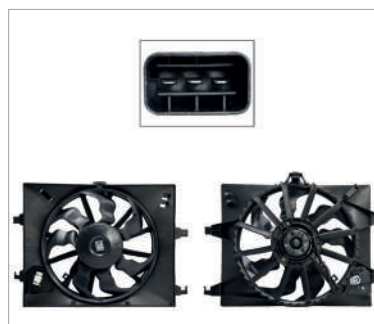

|                                  |                   |
|----------------------------------|-------------------|
| <b>HY</b>                        |                   |
| <b>GRAND I-10 1.2L 2015-2020</b> |                   |
| CÓDIGO:                          | <b>MMND0300</b>   |
| EQUIV 1:                         |                   |
| EQUIV 2:                         |                   |
| OEM:                             | 25380-B4100/B4000 |
|                                  |                   |

MOTOVENTILADOR COMPLETO C/S AIRE C/TOLVA C/RES 3PIN



|                           |                 |
|---------------------------|-----------------|
| <b>KA</b>                 |                 |
| <b>RIO 1.6L 2018-2023</b> |                 |
| CÓDIGO:                   | <b>MMNA0100</b> |
| EQUIV 1:                  |                 |
| EQUIV 2:                  |                 |
| OEM:                      | 25380-H9000     |
|                           |                 |

MOTOVENTILADOR COMPLETO C/AIRE C/TOLVA C/RES 2PIN (ACCENT 18-22) (SEDAN/H-BACK)



|                                   |                 |
|-----------------------------------|-----------------|
| <b>NS</b>                         |                 |
| <b>ALTIMA 2.5L/3.5L 2002-2006</b> |                 |
| CÓDIGO:                           | <b>MMNN3200</b> |
| EQUIV 1:                          |                 |
| EQUIV 2:                          |                 |
| OEM:                              | 21481-8J000     |
|                                   |                 |

MOTOVENTILADOR COMPLETO C/AIRE C/TOLVA S/RES 4PIN (MAXIMA 04-08) (2ASPAS)



|                                   |                 |
|-----------------------------------|-----------------|
| <b>NS</b>                         |                 |
| <b>ALTIMA 2.5L/3.5L 2007-2016</b> |                 |
| CÓDIGO:                           | <b>MMNN3210</b> |
| EQUIV 1:                          |                 |
| EQUIV 2:                          |                 |
| OEM:                              | 21481-JA000     |
|                                   |                 |

MOTOVENTILADOR COMPLETO C/AIRE C/TOLVA C/RES 4PIN (MAXIMA 09-15) (2ASPAS)



|                                   |                 |
|-----------------------------------|-----------------|
| <b>NS</b>                         |                 |
| <b>FRONTIER 4.0L V6 2005-2019</b> |                 |
| CÓDIGO:                           | <b>MMNN2700</b> |
| EQUIV 1:                          |                 |
| EQUIV 2:                          |                 |
| OEM:                              | 92120-9Z400     |
|                                   |                 |

MOTOR DE VENTILADOR SOLO C/AIRE 4PIN (PATHFINDER 05-12/X-TERRA 05-15)



**NS**

### PLATINA 1.6L 2002-2010

|          |                     |
|----------|---------------------|
| CÓDIGO:  | <b>MMNN0301</b>     |
| EQUIV 1: |                     |
| EQUIV 2: | MEGANE-SCENIC 01-10 |
| OEM:     | 92120-00QAA         |



MOTOVENTILADOR S/AIRE S/TOLVA 2PIN (APRIO 08-10/CLIO 02-10) (MOTOR/ASPA)



**NS**

### PLATINA 1.6L 2002-2010

|          |                     |
|----------|---------------------|
| CÓDIGO:  | <b>MMNN0321</b>     |
| EQUIV 1: |                     |
| EQUIV 2: | MEGANE-SCENIC 01-10 |
| OEM:     | 77010-45816         |



MOTOVENTILADOR C/AIRE S/TOLVA 2PIN (APRIO 08-10/CLIO 02-10/KANGOO) (MOTOR/ASPA)



**NS**

### PLATINA 1.6L 2002-2010

|          |                 |
|----------|-----------------|
| CÓDIGO:  | <b>MMNN0352</b> |
| EQUIV 1: |                 |
| EQUIV 2: |                 |
| OEM:     | 92120-00Q0G     |



MOTOVENTILADOR COMPLETO C/AIRE C/TOLVA 2PIN (APRIO 08-10/CLIO 02-10/KANGOO)



**NS**

### SENTRA B-15 1.8L/2.0L/2.5L 2001-2006

|          |                 |
|----------|-----------------|
| CÓDIGO:  | <b>MMNN1350</b> |
| EQUIV 1: |                 |
| EQUIV 2: |                 |
| OEM:     | 21487-0Z800     |



MOTOR DE VENTILADOR SOLO C/AIRE 4PIN (X-TRAIL 01-07/ALTIMA 98-09/MAXIMA 95-99)



**NS**

### SENTRA B-15 1.8L/2.0L/2.5L 2001-2006

|          |                 |
|----------|-----------------|
| CÓDIGO:  | <b>MMNN1351</b> |
| EQUIV 1: |                 |
| EQUIV 2: |                 |
| OEM:     | 21481-6M100     |



MOTOVENTILADOR COMPLETO C/AIRE C/TOLVA S/RES 4PIN (2ASPAS)



**NS**

### SENTRA B-16 2.0L/2.5L 2007-2012

|          |                   |
|----------|-------------------|
| CÓDIGO:  | <b>MMNN1400</b>   |
| EQUIV 1: |                   |
| EQUIV 2: |                   |
| OEM:     | 21481-ET80B/ET000 |



MOTOVENTILADOR COMPLETO C/AIRE C/TOLVA S/RES 4PIN (2ASPAS)



**NS**

### SENTRA B-17 1.8L 2013-2020

|          |                   |
|----------|-------------------|
| CÓDIGO:  | <b>MMNN1800</b>   |
| EQUIV 1: |                   |
| EQUIV 2: |                   |
| OEM:     | 21481-3SH5A/9AM0A |



MOTOVENTILADOR COMPLETO C/S AIRE C/TOLVA S/RES 4PIN

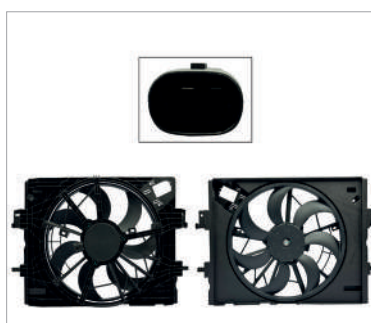

**NS**

### SENTRA B-18 2.0L 2021-2024

|          |                 |
|----------|-----------------|
| CÓDIGO:  | <b>MMNN1600</b> |
| EQUIV 1: |                 |
| EQUIV 2: |                 |
| OEM:     | 21481-6LB0B     |



MOTOVENTILADOR COMPLETO C/S AIRE C/TOLVA S/RES PIN



**NS**

**TIIDA 1.6L/1.8L 2006-2017**

|          |                   |
|----------|-------------------|
| CÓDIGO:  | <b>MMNN1100</b>   |
| EQUIV 1: |                   |
| EQUIV 2: |                   |
| OEM:     | 21487-ED00A/JG30B |

**ISAKA**  
GENUINE AUTO PARTS

MOTOR DE VENTILADOR SOLO C/AIRE 4PIN



**NS**

**TIIDA 1.6L/1.8L 2006-2017**

|          |                 |
|----------|-----------------|
| CÓDIGO:  | <b>MMNN1102</b> |
| EQUIV 1: |                 |
| EQUIV 2: |                 |
| OEM:     | 21481-EL30A     |

**ISAKA**  
GENUINE AUTO PARTS

MOTOVENTILADOR COMPLETO C/AIRE C/TOLVA C/RESISTENCIA 2PIN



**NS**

**TS-III 1.6L 1992-2017**

|          |                 |
|----------|-----------------|
| CÓDIGO:  | <b>MMNN0100</b> |
| EQUIV 1: |                 |
| EQUIV 2: |                 |
| OEM:     | 21487-58Y10     |

**ISAKA**  
GENUINE AUTO PARTS

MOTOR DE VENTILADOR SOLO S/AIRE 2PIN (SENTRA B-14)

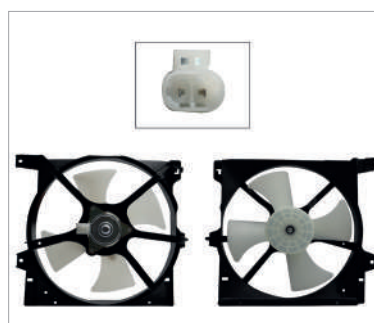

**NS**

**TS-III 1.6L 1992-2017**

|          |                 |
|----------|-----------------|
| CÓDIGO:  | <b>MMNN0101</b> |
| EQUIV 1: |                 |
| EQUIV 2: |                 |
| OEM:     | 21481-58Y01     |

**ISAKA**  
GENUINE AUTO PARTS

MOTOVENTILADOR COMPLETO S/AIRE C/TOLVA 2PIN (SENTRA B-14)



**NS**

**TS-III 1.6L 1992-2017**

|          |                 |
|----------|-----------------|
| CÓDIGO:  | <b>MMNN0150</b> |
| EQUIV 1: |                 |
| EQUIV 2: |                 |
| OEM:     | 92120-73C0C     |

**ISAKA**  
GENUINE AUTO PARTS

MOTOVENTILADOR COMPLETO P/AIRE ACONDICIONADO C/TOLVA 2PIN (SENTRA B-14)

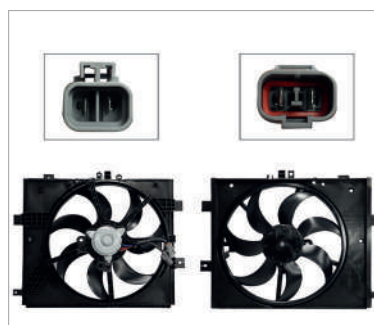

**NS**

**VERSA 1.6L 2012-2019**

|          |                   |
|----------|-------------------|
| CÓDIGO:  | <b>MMNN0900</b>   |
| EQUIV 1: |                   |
| EQUIV 2: |                   |
| OEM:     | 21481-3AB3A/9KK0A |

**ISAKA**  
GENUINE AUTO PARTS

MOTOVENTI COMPLETO C/S AIRE C/T 2PIN S/RES 2CONECTORES 7ASPAS V-DRIVE/MARCH/NOTE



**NS**

**VERSA 1.6L 2012-2019**

|          |                   |
|----------|-------------------|
| CÓDIGO:  | <b>MMNN0901</b>   |
| EQUIV 1: |                   |
| EQUIV 2: |                   |
| OEM:     | 21481-1HS3A/1HW3A |

**ISAKA**  
GENUINE AUTO PARTS

MOTOVENTI COMPLETO C/S AIRE C/T 4PIN S/RES 1CONECTOR 7ASPAS (V-DRIVE/MARCH/NOTE)

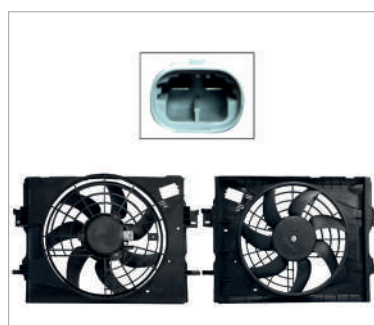

**NS**

**VERSA 1.6L 2020-2024**

|          |                 |
|----------|-----------------|
| CÓDIGO:  | <b>MMNN0910</b> |
| EQUIV 1: |                 |
| EQUIV 2: |                 |
| OEM:     | 21481-5RB0A     |

**ISAKA**  
GENUINE AUTO PARTS

MOTOVENTILADOR COMPLETO C/S AIRE C/TOLVA S/RES 2PIN (KICKS 17-24)



|                               |                 |
|-------------------------------|-----------------|
| <b>NS</b>                     |                 |
| <b>X-TRAIL 2.5L 2001-2007</b> |                 |
| CÓDIGO:                       | <b>MMNN2201</b> |
| EQUIV 1:                      |                 |
| EQUIV 2:                      |                 |
| OEM:                          | 21487-EQ30A     |
|                               |                 |

MOTOVENTILADOR P/RADIADOR S/TOLVA 4PIN (MOTOR/ASPAS)



|                               |                 |
|-------------------------------|-----------------|
| <b>NS</b>                     |                 |
| <b>X-TRAIL 2.5L 2001-2007</b> |                 |
| CÓDIGO:                       | <b>MMNN2202</b> |
| EQUIV 1:                      |                 |
| EQUIV 2:                      |                 |
| OEM:                          | 21487-CX000     |
|                               |                 |

MOTOVENTILADOR P/AIRE ACONDICIONADO S/TOLVA 4PIN (MOTOR/ASPAS)



|                               |                 |
|-------------------------------|-----------------|
| <b>NS</b>                     |                 |
| <b>X-TRAIL 2.5L 2001-2007</b> |                 |
| CÓDIGO:                       | <b>MMRN2200</b> |
| EQUIV 1:                      |                 |
| EQUIV 2:                      |                 |
| OEM:                          | 21481-8H303     |
|                               |                 |

MOTOVENTILADOR COMPLETO C/AIRE C/TOLVA S/RES 4PIN (2ASPAS)

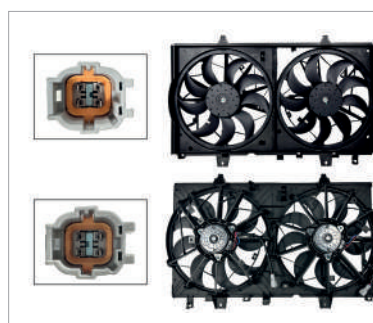

|                               |                 |
|-------------------------------|-----------------|
| <b>NS</b>                     |                 |
| <b>X-TRAIL 2.5L 2015-2022</b> |                 |
| CÓDIGO:                       | <b>MMNN2210</b> |
| EQUIV 1:                      |                 |
| EQUIV 2:                      |                 |
| OEM:                          | 21481-4BA0A     |
|                               |                 |

MOTOVENTILADOR COMPLETO C/S AIRE C/TOLVA S/RES PIN (2ASPAS)

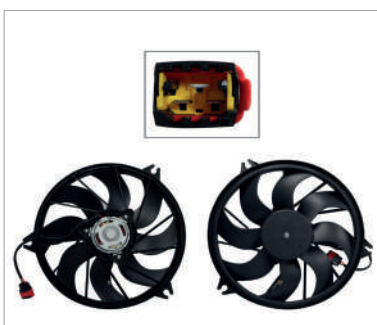

|                                   |                 |
|-----------------------------------|-----------------|
| <b>PG</b>                         |                 |
| <b>PG-206 1.4L/1.6L 1999-2009</b> |                 |
| CÓDIGO:                           | <b>MMNP0101</b> |
| EQUIV 1:                          |                 |
| EQUIV 2:                          |                 |
| OEM:                              | 1253.C9         |
|                                   |                 |

MOTOVENTILADOR C/S AIRE S/TOLVA 2PIN (MOTOR/ASPA)



|                              |                 |
|------------------------------|-----------------|
| <b>PG</b>                    |                 |
| <b>PG-301 1.6L 2013-2017</b> |                 |
| CÓDIGO:                      | <b>MMNP1000</b> |
| EQUIV 1:                     |                 |
| EQUIV 2:                     |                 |
| OEM:                         | 1253-H5         |
|                              |                 |

MOTOVENTILADOR COMPLETO C/AIRE C/TOLVA S/RES (PG-207 08-18/PG-208-2008 14-17)

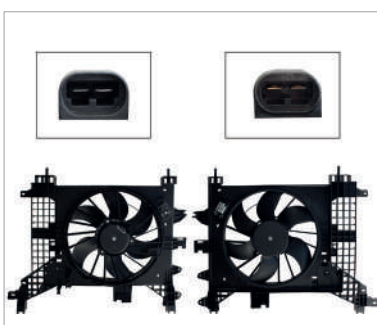

|                              |                 |
|------------------------------|-----------------|
| <b>RT</b>                    |                 |
| <b>DUSTER 2.0L 2013-2016</b> |                 |
| CÓDIGO:                      | <b>MMNR0400</b> |
| EQUIV 1:                     |                 |
| EQUIV 2:                     |                 |
| OEM:                         | 21481-4567R     |
|                              |                 |

MOTOVENTILADOR COMPLETO C/AIRE C/TOLVA C/RES 2PIN



|                              |                 |
|------------------------------|-----------------|
| <b>RT</b>                    |                 |
| <b>KANGOO 1.6L 2014-2018</b> |                 |
| CÓDIGO:                      | <b>MMNR0200</b> |
| EQUIV 1:                     |                 |
| EQUIV 2:                     |                 |
| OEM:                         | 82000-90216     |
|                              |                 |

MOTOVENTILADOR COMPLETO C/AIRE C/TOLVA S/RES 2PIN



**RT**

**LOGAN 1.6L 2015-2019**

|          |                         |
|----------|-------------------------|
| CÓDIGO:  | <b>MMNR0800</b>         |
| EQUIV 1: |                         |
| EQUIV 2: | CAPTUR 18-20/CLIO 15-17 |
| OEM:     | 21481-8009R             |

**ISAKA**  
GENUINE AUTO PARTS

MOTOVENTI COMP C/AIRE C/TOLVA S/RES 2PIN (SANDERO 10-20/DUSTER 17-20/OROCH 19-24)

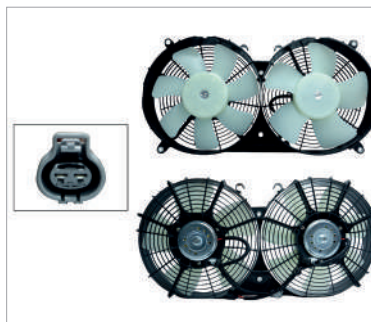

**TY**

**HIACE 2.7L 2005-2019**

|          |                 |
|----------|-----------------|
| CÓDIGO:  | <b>MMNT0400</b> |
| EQUIV 1: |                 |
| EQUIV 2: |                 |
| OEM:     | 16360-75031     |

**ISAKA**  
GENUINE AUTO PARTS

MOTOVENTILADOR COMPLETO C/AIRE C/TOLVA 2PIN (2MOTOR/2ASPA)



**TY**

**YARIS 1.5L 2006-2017**

|          |                 |
|----------|-----------------|
| CÓDIGO:  | <b>MMNT0302</b> |
| EQUIV 1: |                 |
| EQUIV 2: |                 |
| OEM:     | 16711-21110     |

**ISAKA**  
GENUINE AUTO PARTS

MOTOVENTILADOR COMPLETO C/S AIRE C/TOLVA C/DEPOSITO C/RES 2PIN

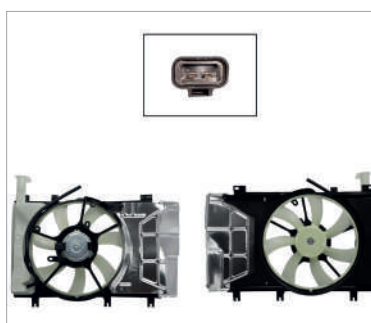

**TY**

**YARIS 1.5L 2018-2020**

|          |                 |
|----------|-----------------|
| CÓDIGO:  | <b>MMNT0310</b> |
| EQUIV 1: |                 |
| EQUIV 2: |                 |
| OEM:     | 16711-0Y190     |

**ISAKA**  
GENUINE AUTO PARTS

MOTOVENTILADOR COMPLETO C/S AIRE C/TOLVA C/DEPOSITO S/RES 2PIN

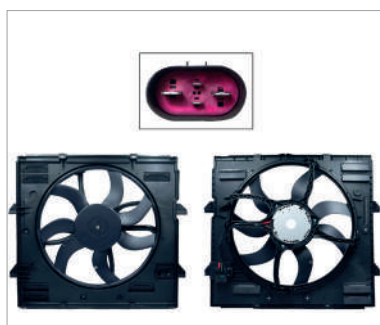

**VK**

**AMAROK 2.0L 2011-2022**

|          |                 |
|----------|-----------------|
| CÓDIGO:  | <b>MMNV4000</b> |
| EQUIV 1: |                 |
| EQUIV 2: |                 |
| OEM:     | 2H0-121-203K    |

**ISAKA**  
GENUINE AUTO PARTS

MOTOVENTILADOR COMPLETO C/AIRE C/TOLVA C/RES 4PIN (MOTOR DC)

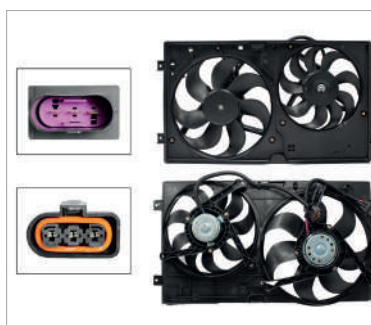

**VK**

**BETLE 1.8L/1.9L/2.0L 1998-2011**

|          |                 |
|----------|-----------------|
| CÓDIGO:  | <b>MMNV2100</b> |
| EQUIV 1: |                 |
| EQUIV 2: |                 |
| OEM:     | 1C0-121-206A    |

**ISAKA**  
GENUINE AUTO PARTS

MOTOVENTILADOR COMPLETO C/AIRE C/TOLVA S/RES 3PIN (2ASPAS)



**VK**

**BORA 1.9L DIESEL 2006-2010**

|          |                   |
|----------|-------------------|
| CÓDIGO:  | <b>MMNV0401</b>   |
| EQUIV 1: |                   |
| EQUIV 2: |                   |
| OEM:     | 1K0-959-455P/R/DG |

**ISAKA**  
GENUINE AUTO PARTS

MOTOVENTILADOR P/AIRE ACOND S/TOLVA 2PIN (PASSAT 06-11/EOS 09-11) (MOTOR/ASPA)



**VK**

**BORA 1.9L DIESEL 2006-2010**

|          |                 |
|----------|-----------------|
| CÓDIGO:  | <b>MMNV0402</b> |
| EQUIV 1: |                 |
| EQUIV 2: |                 |
| OEM:     | 1K0-959-455P/EA |

**ISAKA**  
GENUINE AUTO PARTS

MOTOVENTILADOR COMPLETO C/AIRE C/TOLVA 2-4PIN (2ASPAS)



|                                |                    |
|--------------------------------|--------------------|
| <b>VK</b>                      |                    |
| <b>BORA 2.5L GAS 2006-2010</b> |                    |
| CÓDIGO:                        | <b>MMNV0450</b>    |
| EQUIV 1:                       |                    |
| EQUIV 2:                       |                    |
| OEM:                           | 1K0-959-455N/DT/FJ |
|                                |                    |

MOTOVENTILADOR COMPLETO C/AIRE C/TOLVA 2-4PIN (2ASPAS)



|                                |                  |
|--------------------------------|------------------|
| <b>VK</b>                      |                  |
| <b>BORA 2.5L GAS 2006-2010</b> |                  |
| CÓDIGO:                        | <b>MMNV0452</b>  |
| EQUIV 1:                       |                  |
| EQUIV 2:                       |                  |
| OEM:                           | 1K0-959-455ES/DG |
|                                |                  |

MOTOVENTILADOR P/AIRE ACONDICIONADO S/TOLVA 2PIN (MOTOR/ASPA)



|                             |                 |
|-----------------------------|-----------------|
| <b>VK</b>                   |                 |
| <b>DERBY 1.8L 1999-2009</b> |                 |
| CÓDIGO:                     | <b>MMNV0551</b> |
| EQUIV 1:                    |                 |
| EQUIV 2:                    |                 |
| OEM:                        | 6K0-959-455/B/F |
|                             |                 |

MOTOVENTILADOR P/AIRE ACOND S/TOLVA EMBRA 2PIN (CORDOBA-IBIZA 00-02) MOTOR/ASPA



|                             |                 |
|-----------------------------|-----------------|
| <b>VK</b>                   |                 |
| <b>DERBY 1.8L 1999-2009</b> |                 |
| CÓDIGO:                     | <b>MMNV0552</b> |
| EQUIV 1:                    |                 |
| EQUIV 2:                    |                 |
| OEM:                        | 6K0-959-455A    |
|                             |                 |

MOTOVENTILADOR P/RADIADOR S/TOLVA EMBRA 2PIN (CORDOBA-IBIZA 00-02) (MOTOR/ASPA)



|                           |                 |
|---------------------------|-----------------|
| <b>VK</b>                 |                 |
| <b>GOL 1.6L 2008-2021</b> |                 |
| CÓDIGO:                   | <b>MMNV0601</b> |
| EQUIV 1:                  |                 |
| EQUIV 2:                  |                 |
| OEM:                      | 5U0-959-455B/C  |
|                           |                 |

MOTOVENTILADOR C/AIRE S/TOLVA EMBRA 2PIN (SAVEIRO 10-22) (MOTOR/ASPA)



|                           |                 |
|---------------------------|-----------------|
| <b>VK</b>                 |                 |
| <b>GOL 1.6L 2008-2021</b> |                 |
| CÓDIGO:                   | <b>MMNV0602</b> |
| EQUIV 1:                  |                 |
| EQUIV 2:                  |                 |
| OEM:                      | 5U0-121-207A    |
|                           |                 |

MOTOVENTILADOR COMPLETO C/AIRE C/TOLVA C/RES 3PIN (SAVEIRO 10-22)



|                           |                 |
|---------------------------|-----------------|
| <b>VK</b>                 |                 |
| <b>GOL 1.6L 2008-2021</b> |                 |
| CÓDIGO:                   | <b>MMNV0651</b> |
| EQUIV 1:                  |                 |
| EQUIV 2:                  |                 |
| OEM:                      | 5U0-959-455A    |
|                           |                 |

MOTOVENTILADOR S/AIRE S/TOLVA 2PIN (SAVEIRO 10-22/SPORT VAN 07-09) (MOTOR/ASPA)



|   |                 |
|---|-----------------|
| <b>VK</b>                                   |                 |
| <b>GOLF A5/A6 GTI 1.9L DIESEL 2008-2013</b> |                 |
| CÓDIGO:                                     | <b>MMNV0351</b> |
| EQUIV 1:                                    |                 |
| EQUIV 2:                                    |                 |
| OEM:  | 1K0-959-455CN   |
|   |                 |

MOTOVENTILADOR P/AIRE ACONDICIONADO S/TOLVA 2-4PIN (CADDY 2.0L 16-19) MOTOR/ASPA



**VK**

**GOLF A5/A6 GTI 1.9L DIESEL 2008-2013**

|          |                 |
|----------|-----------------|
| CÓDIGO:  | <b>MMNV0352</b> |
| EQUIV 1: |                 |
| EQUIV 2: |                 |
| OEM:     | 1K0-959-455CP   |
|          |                 |

MOTOVENTILADOR P/RADIADOR S/TOLVA 2-4PIN (CADDY 2.0L 16-19) (MOTOR/ASPA)



**VK**

**JETTA A4/CLASICO 1.8L/2.0L 1999-2015**

|          |                 |
|----------|-----------------|
| CÓDIGO:  | <b>MMNV0111</b> |
| EQUIV 1: | 6F0-959-455-A   |
| EQUIV 2: |                 |
| OEM:     | 1J0-959-455F    |
|          |                 |

MOTOVENTILADOR P/RADIADOR S/TOLVA 3PIN (GOLF A4/IBIZA-CORDOBA-LEON-TOLEDO)



**VK**

**JETTA A6 BICENTENARIO 2.5L 2010-2018**

|          |                 |
|----------|-----------------|
| CÓDIGO:  | <b>MMNV0101</b> |
| EQUIV 1: | 1K0-959-455DH   |
| EQUIV 2: |                 |
| OEM:     | 1KM-959-455E    |
|          |                 |

MOTOVENTILADOR P/AIRE ACOND S/TOLVA 2PIN (BORA 2.5L/GOLF A6 10-13) (MOTOR/ASPA)



**VK**

**JETTA A6 BICENTENARIO 2.5L 2010-2018**

|          |                 |
|----------|-----------------|
| CÓDIGO:  | <b>MMNV0102</b> |
| EQUIV 1: |                 |
| EQUIV 2: |                 |
| OEM:     | 1KM-959-455G    |
|          |                 |

MOTOVENTILADOR P/RADIADOR S/TOLVA 2-4PIN (BORA 06-10) (MOTOR/ASPA)



**VK**

**JETTA/GOLF A2 1.8L 1987-1992**

|          |                 |
|----------|-----------------|
| CÓDIGO:  | <b>MMNV0121</b> |
| EQUIV 1: |                 |
| EQUIV 2: |                 |
| OEM:     | 130-107-262     |
|          |                 |

MOTOVENTILADOR S/AIRE S/TOLVA 2PIN (MOTOR/ASPA)



**VK**

**JETTA/GOLF A2 1.8L 1987-1992**

|          |                 |
|----------|-----------------|
| CÓDIGO:  | <b>MMNV0122</b> |
| EQUIV 1: |                 |
| EQUIV 2: |                 |
| OEM:     | 165-959-455L    |
|          |                 |

MOTOVENTILADOR C/AIRE S/TOLVA 3PIN (MOTOR/ASPA)



**VK**

**JETTA/GOLF A3 1.8L/2.0L 1993-1998**

|          |                 |
|----------|-----------------|
| CÓDIGO:  | <b>MMNV0131</b> |
| EQUIV 1: |                 |
| EQUIV 2: |                 |
| OEM:     | 1H0-959-455     |
|          |                 |

MOTOVENTILADOR S/AIRE S/TOLVA 3PIN (MOTOR/ASPA)



**VK**

**JETTA/GOLF A4 1.8L/2.0L 1999-2007**

|          |                 |
|----------|-----------------|
| CÓDIGO:  | <b>MMNV0112</b> |
| EQUIV 1: |                 |
| EQUIV 2: |                 |
| OEM:     | 1J0-959-455K    |
|          |                 |

MOTOVENTILADOR P/AIRE ACONDICIONADO S/TOLVA CHICO EMBRA 3PIN (MOTOR/ASPA)



**VK**

**LUPO/POLO 1.6L/2.0L 2003-2016**

|          |                 |
|----------|-----------------|
| CÓDIGO:  | <b>MMNV1301</b> |
| EQUIV 1: |                 |
| EQUIV 2: |                 |
| OEM:     | 6X0-959-455C    |

**ISAKA**  
GENUINE AUTO PARTS

MOTOVENTILADOR P/RADIADOR S/TOLVA GRANDE 3PIN (MOTOR/ASPA)



**VK**

**LUPO/POLO 1.6L/2.0L 2003-2016**

|          |                 |
|----------|-----------------|
| CÓDIGO:  | <b>MMNV1351</b> |
| EQUIV 1: |                 |
| EQUIV 2: |                 |
| OEM:     | 6Q0-959-455J    |

**ISAKA**  
GENUINE AUTO PARTS

MOTOVENTILADOR P/AIRE ACONDICIONADO S/TOLVA CHICO 2PIN (IBIZA-CORDOBA 03-12)



**VK**

**POINTER 1.8L 1998-2009**

|          |                 |
|----------|-----------------|
| CÓDIGO:  | <b>MMNV0201</b> |
| EQUIV 1: |                 |
| EQUIV 2: |                 |
| OEM:     | 377-959-455H    |

**ISAKA**  
GENUINE AUTO PARTS

MOTOVENTILADOR S/AIRE S/TOLVA 2PIN (VAGONETA/PICK-UP) (MOTOR/ASPA)



**VK**

**POINTER 1.8L 1998-2009**

|          |                 |
|----------|-----------------|
| CÓDIGO:  | <b>MMNV0251</b> |
| EQUIV 1: |                 |
| EQUIV 2: |                 |
| OEM:     | 130-451-165     |

**ISAKA**  
GENUINE AUTO PARTS

MOTOVENTILADOR C/AIRE S/TOLVA 2PIN (VAGONETA/PICK-UP) (MOTOR/ASPA)



**VK**

**VENTO 1.6L 2014-2015**

|          |                           |
|----------|---------------------------|
| CÓDIGO:  | <b>MMNV0700</b>           |
| EQUIV 1: |                           |
| EQUIV 2: | LUPO 04-09/SPORTVAN 07-09 |
| OEM:     | 6Q0-959-455AE             |

**ISAKA**  
GENUINE AUTO PARTS

MOTOVENTILADOR C/S AIRE S/TOLVA 3PIN POLO 03-07 13-15/CROSSFOX 07-09/IBIZA 10-17



**VK**

**VENTO 1.6L 2014-2015**

|          |                           |
|----------|---------------------------|
| CÓDIGO:  | <b>MMNV0710</b>           |
| EQUIV 1: |                           |
| EQUIV 2: | LUPO 04-09/SPORTVAN 07-09 |
| OEM:     | 6R0-949-455C              |

**ISAKA**  
GENUINE AUTO PARTS

MOTOVENTI COMP C/S AIRE C/TOLVA 3PIN POLO 03-07 13-15/CROSSFOX 07-09/IBIZA 10-17



**VK**

**VENTO 1.6L 2016-2022**

|          |                 |
|----------|-----------------|
| CÓDIGO:  | <b>MMNV0720</b> |
| EQUIV 1: |                 |
| EQUIV 2: |                 |
| OEM:     | 6R0-959-455D    |

**ISAKA**  
GENUINE AUTO PARTS

MOTOVENTI C/S AIRE S/TOLVA 4PIN (POLO-TOLEDO 13-19/AD A1 10-19) (MOTOR DC/ASPA)



**VK**

**VENTO 1.6L 2016-2022**

|          |                 |
|----------|-----------------|
| CÓDIGO:  | <b>MMNV0730</b> |
| EQUIV 1: |                 |
| EQUIV 2: |                 |
| OEM:     | 6R0-121-207Q    |

**ISAKA**  
GENUINE AUTO PARTS

MOTOVENTI COMP C/S AIRE C/TOLVA 4PIN (POLO-TOLEDO 13-19/AD A1 10-19) (MOTOR DC)



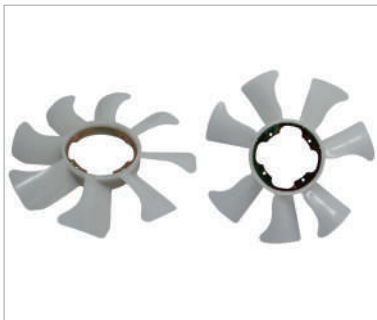

**NS**

**D-21 2/4WD 2.4L 1994-2007**

|          |                 |
|----------|-----------------|
| CÓDIGO:  | <b>MMTN0200</b> |
| EQUIV 1: |                 |
| EQUIV 2: |                 |
| OEM:     | 21060-86G00     |



ASPAS DE VENTILADOR 12VAL/16VAL 7PALETAS (NP-300 D-22 2-4WD 08-15)

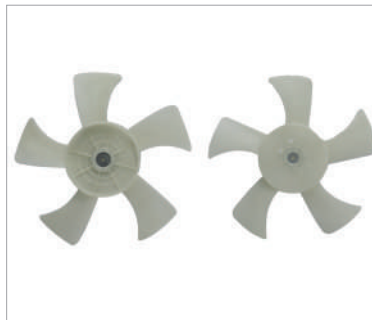

**NS**

**TS-III 1.6L 1992-2017**

|          |                   |
|----------|-------------------|
| CÓDIGO:  | <b>MMRN0100</b>   |
| EQUIV 1: |                   |
| EQUIV 2: |                   |
| OEM:     | 21486-58Y00/53J00 |

ASPAS DE VENTILADOR DE AIRE ACOND 5PALETAS (TS-II 88-91)

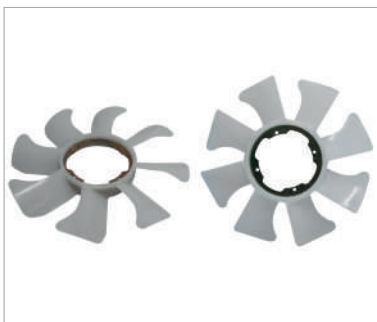

**NS**

**URVAN 2.4L 2000-2006**

|          |                 |
|----------|-----------------|
| CÓDIGO:  | <b>MMTN0400</b> |
| EQUIV 1: |                 |
| EQUIV 2: |                 |
| OEM:     | 21060-VW000     |



ASPAS DE VENTILADOR KA24DE 16VAL 8PALETAS

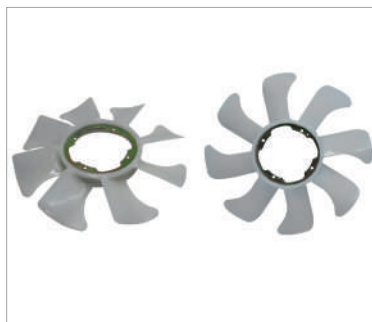

**NS**

**URVAN 2.5L/3.0L 2007-2012**

|          |                 |
|----------|-----------------|
| CÓDIGO:  | <b>MMTN0410</b> |
| EQUIV 1: |                 |
| EQUIV 2: |                 |
| OEM:     | 21060-VW200     |



ASPAS DE VENTILADOR QR25DE/ZD30DDTI 8PALETAS (NV-350 13-22)

# FAN CLUTCH

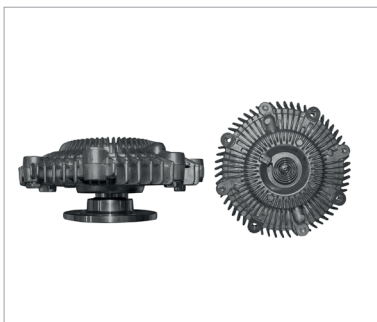

**NS**

**D-21 2/4WD 2.4L 1994-2007**

|          |                  |
|----------|------------------|
| CÓDIGO:  | <b>MFNN0200</b>  |
| EQUIV 1: | MFC22082/KG-2560 |
| EQUIV 2: |                  |
| OEM:     | 21082-86G00      |



FAN CLUTCH POLEA TERMICA (D-22 2.4L 08-15/720/Frontier 2.4L/X-TERRA)

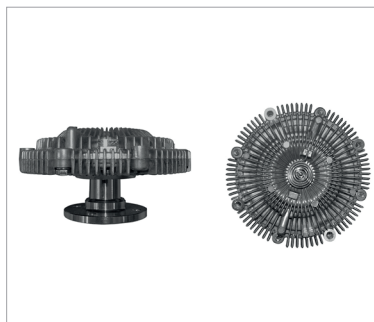

**NS**

**NP-300 (D-22) 4WD 2.5L 2008-2015**

|          |                 |
|----------|-----------------|
| CÓDIGO:  | <b>MFNN0700</b> |
| EQUIV 1: | MFC6000         |
| EQUIV 2: |                 |
| OEM:     | 21082-VB100     |



FAN CLUTCH POLEA TERMICA DIESEL YD25DDTI (NV-350 2.5L DIESEL)



**NS**

**NP-300 FRONTIER (D-23) 2016-2024**

|          |                 |
|----------|-----------------|
| CÓDIGO:  | <b>MFNN0710</b> |
| EQUIV 1: |                 |
| EQUIV 2: |                 |
| OEM:     | 21082-4JM1A     |



FAN CLUTCH POLEA TERMICA 2/4WD (2.5L GASOLINA) (SENCILLA/DOBLE CABINA)

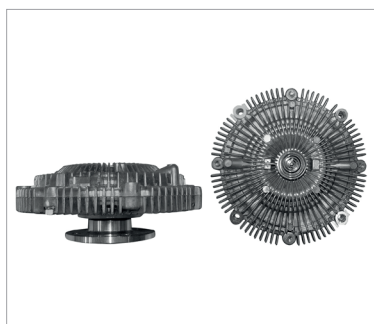

**NS**

**URVAN 2.4L/2.5L 2002-2012**

|          |                 |
|----------|-----------------|
| CÓDIGO:  | <b>MFNN0400</b> |
| EQUIV 1: | MFC6003/KG-5823 |
| EQUIV 2: |                 |
| OEM:     | 21082-VW000/1   |



FAN CLUTCH POLEA TERMICA 16VAL GRANDE KA24DE/QR25DE (NV-350 13-22)



|                            |                 |
|----------------------------|-----------------|
| <b>CV</b>                  |                 |
| <b>AVEO 1.6L 2007-2017</b> |                 |
| CÓDIGO:                    | <b>MHNC9900</b> |
| EQUIV 1:                   | KGT-2729-HT     |
| EQUIV 2:                   |                 |
| OEM:                       | 25192228        |
|                            |                 |

TOMA AGUA ALUMINIO COMPLETA C/TERM C/SENSOR (SONIC-G3 1.6L/CRUZE-TRAX 1.8L)



|                                  |                   |
|----------------------------------|-------------------|
| <b>CV</b>                        |                   |
| <b>CHEVY 1.4L/1.6L 1994-2012</b> |                   |
| CÓDIGO:                          | <b>MHNC0100</b>   |
| EQUIV 1:                         | KGTE-8854         |
| EQUIV 2:                         |                   |
| OEM:                             | 93227142/90448854 |
|                                  |                   |

TOMA AGUA PLASTICO (C-2/C-3/CHEVY PICK-UP 99-04)



|                             |                 |
|-----------------------------|-----------------|
| <b>CV</b>                   |                 |
| <b>CORSA 1.8L 2003-2008</b> |                 |
| CÓDIGO:                     | <b>MHNC0200</b> |
| EQUIV 1:                    | KGT-540-198T    |
| EQUIV 2:                    |                 |
| OEM:                        | 93275736        |
|                             |                 |

TOMA AGUA METAL COMPLETA C/TERM C/CARCASE (CHEVY 01-03/C-2/C-3/TORNADO/MERIVA)



|                                    |                 |
|------------------------------------|-----------------|
| <b>FD</b>                          |                 |
| <b>FIESTA FIRST 1.6L 2003-2010</b> |                 |
| CÓDIGO:                            | <b>MHNF0200</b> |
| EQUIV 1:                           | KGT-586D1-T     |
| EQUIV 2:                           |                 |
| OEM:                               | 2S6G-8A586D1CAL |
|                                    |                 |

TOMA AGUA ALUMINIO COMPLETA CURVA C/TERM C/SENSOR (COURIER 01-10/KA 01-08)



|                                    |                 |
|------------------------------------|-----------------|
| <b>FD</b>                          |                 |
| <b>FIESTA FIRST 1.6L 2003-2010</b> |                 |
| CÓDIGO:                            | <b>MHNF0201</b> |
| EQUIV 1:                           | KGT-586D1C-NT   |
| EQUIV 2:                           |                 |
| OEM:                               | 2S6G-8A586D1CPU |
|                                    |                 |

TOMA AGUA PLASTICO COMPLETA CURVA C/TERM C/SENSOR (COURIER 01-10/KA 01-08)



|                                   |                 |
|-----------------------------------|-----------------|
| <b>FD</b>                         |                 |
| <b>FIESTA IKON 1.6L 2001-2007</b> |                 |
| CÓDIGO:                           | <b>MHNF0300</b> |
| EQUIV 1:                          | KGT-586AL-T     |
| EQUIV 2:                          |                 |
| OEM:                              | XS63-8A586AL    |
|                                   |                 |

TOMA AGUA ALUMINIO COMPLETA RECTA C/TERM C/SENSOR (FIESTA 01-04/KA 01-08)



|                                   |                 |
|-----------------------------------|-----------------|
| <b>FD</b>                         |                 |
| <b>FIESTA IKON 1.6L 2001-2007</b> |                 |
| CÓDIGO:                           | <b>MHNF0301</b> |
| EQUIV 1:                          | KGT-586AL-NT    |
| EQUIV 2:                          |                 |
| OEM:                              | XS6E-8A586PU    |
|                                   |                 |

TOMA AGUA PLASTICO COMPLETA RECTA C/TERM C/SENSOR (FIESTA 01-04/KA 01-08)



|                                  |                 |
|----------------------------------|-----------------|
| <b>HY</b>                        |                 |
| <b>GRAND I-10 1.2L 2015-2023</b> |                 |
| CÓDIGO:                          | <b>MHND0300</b> |
| EQUIV 1:                         |                 |
| EQUIV 2:                         |                 |
| OEM:                             | 25631-03011     |
|                                  |                 |

TOMA AGUA PLASTICO



**NS**

**TS-III 1.6L 1995-2017**

|          |                 |
|----------|-----------------|
| CÓDIGO:  | <b>MHNN0110</b> |
| EQUIV 1: | KGT-4300        |
| EQUIV 2: |                 |
| OEM:     | 13049-F4300     |



TOMA AGUA METAL CODO DE TERMOSTATO 16VAL (TSUBAME 92-04)

# DEPOSITO ANTICONGELANTE



CV

## ASTRA 1.8L 2000-2006

|          |                 |
|----------|-----------------|
| CÓDIGO:  | <b>MXNC1410</b> |
| EQUIV 1: | DAKG15370       |
| EQUIV 2: |                 |
| OEM:     | 93179469        |



DEPOSITO ANTICONGELANTE C/TAPON 2SALIDAS JUNTAS (ASTRA 2.0L 06-08)



CV

## ASTRA 2.0L/2.2L/2.4L 2000-2006

|          |                 |
|----------|-----------------|
| CÓDIGO:  | <b>MXNC1420</b> |
| EQUIV 1: |                 |
| EQUIV 2: |                 |
| OEM:     | 90530689        |



DEPOSITO ANTICONGELANTE C/TAPON S/SENSOR 2SALIDAS SEPARADA



CV

## ASTRA 2.0L/2.2L/2.4L 2004-2006

|          |                 |
|----------|-----------------|
| CÓDIGO:  | <b>MXNC1430</b> |
| EQUIV 1: |                 |
| EQUIV 2: |                 |
| OEM:     | 90530688        |



DEPOSITO ANTICONGELANTE C/TAPON C/SENSOR 1SALIDA



CV

## ASTRA 2.2L/2.4L 2004-2006

|          |                 |
|----------|-----------------|
| CÓDIGO:  | <b>MXNC1400</b> |
| EQUIV 1: | DAKG117437      |
| EQUIV 2: |                 |
| OEM:     | 90530687/911737 |



DEPOSITO ANTICONGELANTE C/TAPON C/SENSOR 2SALIDAS SEPARADA (ZAFIRA 1.8L-2.2L)



CV

## AVEO 1.6L 2007-2017

|          |                 |
|----------|-----------------|
| CÓDIGO:  | <b>MXNC9900</b> |
| EQUIV 1: | DAKG15542       |
| EQUIV 2: |                 |
| OEM:     | 96817343        |



DEPOSITO ANTICONGELANTE C/TAPON (PT G3 06-09)



CV

## CHEVY 1.4L/1.6L 1994-2012

|          |                   |
|----------|-------------------|
| CÓDIGO:  | <b>MXNC0100</b>   |
| EQUIV 1: | DAKG4150AM        |
| EQUIV 2: |                   |
| OEM:     | 93217461/92089948 |



DEPOSITO ANTICONGELANTE C/TAPON (C-2/C-3/CHEVY PICK-UP 99-04)



CV

## CORSA 1.8L 2003-2005

|          |                 |
|----------|-----------------|
| CÓDIGO:  | <b>MXNC0200</b> |
| EQUIV 1: | DAKG367723      |
| EQUIV 2: |                 |
| OEM:     | 93367723        |



DEPOSITO ANTICONGELANTE C/TAPON S/AIRE 2SALIDAS (TORNADO 04-11)



CV

## CORSA 1.8L 2006-2008

|          |                 |
|----------|-----------------|
| CÓDIGO:  | <b>MXNC0210</b> |
| EQUIV 1: | DAKG367722      |
| EQUIV 2: |                 |
| OEM:     | 93367722        |



DEPOSITO ANTICONGELANTE C/TAPON C/AIRE 3SALIDAS (TORNADO 04-11)

# DEPOSITO ANTICONGELANTE



**CV**

**MALIBU 2.2L/2.4L/3.1L/3.5L 1997-2007**

|          |                   |
|----------|-------------------|
| CÓDIGO:  | <b>MXNC3000</b>   |
| EQUIV 1: | DAKG712361/712361 |
| EQUIV 2: |                   |
| OEM:     | 22712361          |



DEPOSITO ANTICONGELANTE C/TAPON C/SENSOR 2SALIDAS (CAVALIER/  
GRAND AM/SUNFIRE)



**CV**

**MATIZ G2 1.0L 2006-2015**

|          |                 |
|----------|-----------------|
| CÓDIGO:  | <b>MXNG0111</b> |
| EQUIV 1: | DAKG91467       |
| EQUIV 2: |                 |
| OEM:     | 96591467        |



DEPOSITO ANTICONGELANTE C/TAPON



**CV**

**OPTRA 2.0L 2006-2010**

|          |                 |
|----------|-----------------|
| CÓDIGO:  | <b>MXNC1710</b> |
| EQUIV 1: | DAKG813425      |
| EQUIV 2: |                 |
| OEM:     | 96813425        |



DEPOSITO ANTICONGELANTE C/TAPON (FORENZA 2.0L 04-08)



**CV**

**SPARK 1.2L 2011-2017**

|          |                   |
|----------|-------------------|
| CÓDIGO:  | <b>MXNC0800</b>   |
| EQUIV 1: | DAKG15000         |
| EQUIV 2: |                   |
| OEM:     | 95077578/42620261 |



DEPOSITO ANTICONGELANTE C/TAPON (BEAT 1.2L 18-21)



**DG**

**ATOS 1.0L/1.1L 2000-2012**

|          |                 |
|----------|-----------------|
| CÓDIGO:  | <b>MXNK0100</b> |
| EQUIV 1: |                 |
| EQUIV 2: |                 |
| OEM:     | 98610-02000     |



DEPOSITO LIMPIADORES S/TAPON



**DG**

**ATOS 1.0L/1.1L 2000-2012**

|          |                 |
|----------|-----------------|
| CÓDIGO:  | <b>MXNK0110</b> |
| EQUIV 1: |                 |
| EQUIV 2: |                 |
| OEM:     | 25430-02000     |



DEPOSITO ANTICONGELANTE C/TAPON



**DG**

**ATTITUDE 1.2L 2015-2024**

|          |                 |
|----------|-----------------|
| CÓDIGO:  | <b>MXNK1110</b> |
| EQUIV 1: |                 |
| EQUIV 2: |                 |
| OEM:     | 1375A209        |



DEPOSITO ANTICONGELANTE C/TAPON (MT MIRAGE-G4 15-24)



**DG**

**ATTITUDE 1.4L/1.6L 2006-2011**

|          |                         |
|----------|-------------------------|
| CÓDIGO:  | <b>MXNK1100</b>         |
| EQUIV 1: |                         |
| EQUIV 2: |                         |
| OEM:     | 25431-1G000/25430-1E000 |



DEPOSITO ANTICONGELANTE C/TAPON

# DEPOSITO ANTICONGELANTE



|                            |                 |
|----------------------------|-----------------|
| <b>DG</b>                  |                 |
| <b>I-10 1.1L 2011-2014</b> |                 |
| CÓDIGO:                    | <b>MXNK0800</b> |
| EQUIV 1:                   |                 |
| EQUIV 2:                   |                 |
| OEM:                       | 25431-0X000     |
|                            |                 |

DEPOSITO ANTICONGELANTE C/TAPON



|                               |                       |
|-------------------------------|-----------------------|
| <b>FD</b>                     |                       |
| <b>COURIER 1.6L 2001-2010</b> |                       |
| CÓDIGO:                       | <b>MXNF1200</b>       |
| EQUIV 1:                      | DAK GK218AG           |
| EQUIV 2:                      |                       |
| OEM:                          | M96F-B8K218AG/1102678 |
|                               |                       |

DEPOSITO ANTICONGELANTE C/TAPON S/AIRE 2SALIDAS SEPARADA



|                              |                 |
|------------------------------|-----------------|
| <b>FD</b>                    |                 |
| <b>FIESTA 1.6L 2011-2019</b> |                 |
| CÓDIGO:                      | <b>MXNF0200</b> |
| EQUIV 1:                     | DAKGBE8Z8A      |
| EQUIV 2:                     |                 |
| OEM:                         | BE8Z-8A080A     |
|                              |                 |

DEPOSITO ANTICONGELANTE C/TAPON (FIGO 1.5L 16-22/ECOSPORT 2.0L 13-17)



|                                    |                 |
|------------------------------------|-----------------|
| <b>FD</b>                          |                 |
| <b>FIESTA FIRST 1.6L 2003-2010</b> |                 |
| CÓDIGO:                            | <b>MXNF0210</b> |
| EQUIV 1:                           | DAK GK218BA     |
| EQUIV 2:                           |                 |
| OEM:                               | 2S65-8K218BA    |
|                                    |                 |

DEPOSITO ANTICONGELANTE C/TAPON 1SALIDA (ECOSPORT 04-12)



|                                    |                 |
|------------------------------------|-----------------|
| <b>FD</b>                          |                 |
| <b>FIESTA FIRST 1.6L 2003-2010</b> |                 |
| CÓDIGO:                            | <b>MXNF0230</b> |
| EQUIV 1:                           | DAK G8K218B     |
| EQUIV 2:                           |                 |
| OEM:                               | 2S65-8K218B     |
|                                    |                 |

DEPOSITO ANTICONGELANTE C/TAPON 2SALIDAS JUNTAS



|   |                      |
|---|----------------------|
| <b>FD</b>                                   |                      |
| <b>FIESTA IKON 1.3L/1.4L/1.6L 1998-2010</b> |                      |
| CÓDIGO:                                     | <b>MXNF0300</b>      |
| EQUIV 1:                                    |                      |
| EQUIV 2:                                    |                      |
| OEM:  | 96FB-8K218BG/1105652 |
|   |                      |

DEPOSITO ANTICONGELANTE C/TAPON 2TUBOS (FIESTA FIRST 03-10)



|                          |                 |
|--------------------------|-----------------|
| <b>FD</b>                |                 |
| <b>KA 1.6L 2001-2008</b> |                 |
| CÓDIGO:                  | <b>MXNF1500</b> |
| EQUIV 1:                 | DAK GK218AA     |
| EQUIV 2:                 |                 |
| OEM:                     | M98K-U8K218AA   |
|                          |                 |

DEPOSITO ANTICONGELANTE C/TAPON 2TUBOS



|                                 |                 |
|---------------------------------|-----------------|
| <b>MZ</b>                       |                 |
| <b>CX-5 2.0L/2.5L 2013-2023</b> |                 |
| CÓDIGO:                         | <b>MXRZ0200</b> |
| EQUIV 1:                        |                 |
| EQUIV 2:                        |                 |
| OEM:                            | PE01-15351A     |
|                                 |                 |

DEPOSITO ANTICONGELANTE C/TAPON (MZ 3 2.0L-2.5L 14-24/MZ 6 2.5L 14-21)

# DEPOSITO ANTICONGELANTE



**NS**

**D-21 2/4WD 2.4L 1994-2007**

|          |                 |
|----------|-----------------|
| CÓDIGO:  | <b>MXRN0200</b> |
| EQUIV 1: |                 |
| EQUIV 2: |                 |
| OEM:     | 28910-15G00     |

DEPOSITO LIMPIADORES C/TAPON C/MOTOR



**NS**

**NP-300 (D-22) 2WD 2.4L 2008-2015**

|          |                 |
|----------|-----------------|
| CÓDIGO:  | <b>MXNN0700</b> |
| EQUIV 1: |                 |
| EQUIV 2: |                 |
| OEM:     | 28910-VK600     |



DEPOSITO LIMPIADORES C/TAPON C/2MOTORES (D-22 4WD 2.5L/FRONTIER 98-15)



**NS**

**NP-300 (D-22) 2WD 2.4L 2008-2015**

|          |                 |
|----------|-----------------|
| CÓDIGO:  | <b>MXNN0710</b> |
| EQUIV 1: | DAKG21810       |
| EQUIV 2: |                 |
| OEM:     | 21710-2S60A     |



DEPOSITO ANTICONGELANTE C/TAPON (D-22 4WD 2.5L/X-TERRA 2.4L-3.3L 00-04)



**NS**

**NP-300 (D-22) 2WD 2.4L 2008-2015**

|          |                 |
|----------|-----------------|
| CÓDIGO:  | <b>MXNN0720</b> |
| EQUIV 1: |                 |
| EQUIV 2: |                 |
| OEM:     | 28910-VK60B     |



DEPOSITO LIMPIADORES C/TAPON C/1MOTOR (D-22 4WD 2.5L)



**NS**

**PLATINA 1.6L 2002-2010**

|          |                 |
|----------|-----------------|
| CÓDIGO:  | <b>MXNN0310</b> |
| EQUIV 1: | DAKG000QAA      |
| EQUIV 2: |                 |
| OEM:     | 21710-00QAA     |



DEPOSITO ANTICONGELANTE C/TAPON (APRIO/CLIO 1.6L/DUSTER/SANDERO/STEPWAY/KANGOO)



**NS**

**SENTRA B-15 1.8L/2.0L/2.5L 2001-2006**

|          |                 |
|----------|-----------------|
| CÓDIGO:  | <b>MXNN1310</b> |
| EQUIV 1: | DAKG21610       |
| EQUIV 2: |                 |
| OEM:     | 21710-6M110     |



DEPOSITO ANTICONGELANTE C/TAPON (X-TRAIL 2.5L 01-07/ALMERA 1.8L 01-06)



**NS**

**SENTRA B-15 1.8L/2.0L/2.5L 2001-2006**

|          |                 |
|----------|-----------------|
| CÓDIGO:  | <b>MXRN1300</b> |
| EQUIV 1: |                 |
| EQUIV 2: |                 |
| OEM:     | 28910-F460A     |

DEPOSITO LIMPIADORES C/TAPON C/MOTOR



**NS**

**SENTRA B-16 2.0L/2.5L 2007-2012**

|          |                 |
|----------|-----------------|
| CÓDIGO:  | <b>MXNN1400</b> |
| EQUIV 1: | DAKG21910       |
| EQUIV 2: |                 |
| OEM:     | 21711-ET000     |



DEPOSITO ANTICONGELANTE C/TAPON



# DEPOSITO ANTICONGELANTE



|                                   |                 |
|-----------------------------------|-----------------|
| <b>NS</b>                         |                 |
| <b>SENTRA B-17 1.8L 2013-2020</b> |                 |
| CÓDIGO:                           | <b>MXNN1800</b> |
| EQUIV 1:                          |                 |
| EQUIV 2:                          |                 |
| OEM:                              | 21710-3SH0A     |
|                                   |                 |

DEPOSITO ANTICONGELANTE C/TAPON



|                                  |                   |
|----------------------------------|-------------------|
| <b>NS</b>                        |                   |
| <b>TIIDA 1.6L/1.8L 2006-2017</b> |                   |
| CÓDIGO:                          | <b>MXRN1100</b>   |
| EQUIV 1:                         | DAKG7031CL        |
| EQUIV 2:                         |                   |
| OEM:                             | 21710-1FA0A/ED000 |
|                                  |                   |

DEPOSITO ANTICONGELANTE C/TAPON (CUBE 09-14)



|                             |                 |
|-----------------------------|-----------------|
| <b>NS</b>                   |                 |
| <b>TS-II 1.6L 1988-1991</b> |                 |
| CÓDIGO:                     | <b>MXRN0500</b> |
| EQUIV 1:                    |                 |
| EQUIV 2:                    |                 |
| OEM:                        | 28910-50A00     |
|                             |                 |

DEPOSITO LIMPIADORES C/TAPON C/MOTOR



|                             |                 |
|-----------------------------|-----------------|
| <b>NS</b>                   |                 |
| <b>TS-II 1.6L 1988-1991</b> |                 |
| CÓDIGO:                     | <b>MXRN0510</b> |
| EQUIV 1:                    |                 |
| EQUIV 2:                    |                 |
| OEM:                        | 21710-50A10     |
|                             |                 |

DEPOSITO ANTICONGELANTE C/TAPON



|                              |                 |
|------------------------------|-----------------|
| <b>NS</b>                    |                 |
| <b>TS-III 1.6L 1992-2017</b> |                 |
| CÓDIGO:                      | <b>MXRN0100</b> |
| EQUIV 1:                     | KGDL28910       |
| EQUIV 2:                     |                 |
| OEM:                         | 28910-65Y00     |
|                              |                 |

DEPOSITO LIMPIADORES C/MOTOR C/MANGUERA (TSUBAME)



|                              |                 |
|------------------------------|-----------------|
| <b>NS</b>                    |                 |
| <b>TS-III 1.6L 1992-2017</b> |                 |
| CÓDIGO:                      | <b>MXRN0110</b> |
| EQUIV 1:                     | DAKG21710       |
| EQUIV 2:                     |                 |
| OEM:                         | 21710-69Y11     |
|                              |                 |

DEPOSITO ANTICONGELANTE C/TAPON (B-14/TSUBAME)



|                             |                         |
|-----------------------------|-------------------------|
| <b>NS</b>                   |                         |
| <b>URVAN 2.4L 2002-2006</b> |                         |
| CÓDIGO:                     | <b>MXNN0410</b>         |
| EQUIV 1:                    | DAKG21510               |
| EQUIV 2:                    |                         |
| OEM:                        | 21710-VW000/28910-VW085 |
|                             |                         |

DEPOSITO ANTICONGELANTE C/TAPON (URVAN 3.0L DIESEL 07-12)



|                             |                 |
|-----------------------------|-----------------|
| <b>NS</b>                   |                 |
| <b>URVAN 2.5L 2007-2012</b> |                 |
| CÓDIGO:                     | <b>MXNN0411</b> |
| EQUIV 1:                    | DAKG21110       |
| EQUIV 2:                    |                 |
| OEM:                        | 21710-VZ00A     |
|                             |                 |

DEPOSITO ANTICONGELANTE C/TAPON (NV-350 13-22)

# DEPOSITO ANTICONGELANTE



**NS**

**VERSA 1.6L 2012-2019**

|          |                         |
|----------|-------------------------|
| CÓDIGO:  | <b>MXNN0900</b>         |
| EQUIV 1: |                         |
| EQUIV 2: |                         |
| OEM:     | 21710-1HC1A/1HS0A/1HS3A |



DEPOSITO ANTICONGELANTE C/TAPON (V-DRIVE/MARCH 11-24/NOTE 14-19)



**NS**

**VERSA 1.6L 2020-2024**

|          |                 |
|----------|-----------------|
| CÓDIGO:  | <b>MXNN0910</b> |
| EQUIV 1: |                 |
| EQUIV 2: |                 |
| OEM:     | 21710-5RB0A     |



DEPOSITO ANTICONGELANTE C/TAPON (KICKS 17-24)



**RT**

**MEGANE 2.0L 2005-2010**

|          |                 |
|----------|-----------------|
| CÓDIGO:  | <b>MXNR0300</b> |
| EQUIV 1: | DAKG74999       |
| EQUIV 2: |                 |
| OEM:     | 7701474499      |



DEPOSITO ANTICONGELANTE C/TAPON (SCENIC 2.0L 05-09)



**TY**

**HIACE 2.7L 2005-2019**

|          |                 |
|----------|-----------------|
| CÓDIGO:  | <b>MXNT0410</b> |
| EQUIV 1: | DAKG75121       |
| EQUIV 2: |                 |
| OEM:     | 16470-75121     |



DEPOSITO ANTICONGELANTE C/TAPON



**TY**

**HILUX 2.7L 2006-2015**

|          |                 |
|----------|-----------------|
| CÓDIGO:  | <b>MXRT0700</b> |
| EQUIV 1: |                 |
| EQUIV 2: |                 |
| OEM:     | 85315-0K010-PFM |

DEPOSITO LIMPIADORES C/TAPON C/MOTOR



**VK**

**BORA 2.0L/2.5L 2006-2010**

|          |                 |
|----------|-----------------|
| CÓDIGO:  | <b>MXNV0410</b> |
| EQUIV 1: | DAKG21407K      |
| EQUIV 2: |                 |
| OEM:     | 1K0-121-407A    |



DEPOSITO ANTICONGELANTE C/TAPON (JETTA A6 2.5L/BETLE 12-16/TIGUAN/PASSAT)



**VK**

**GOL 1.6L 2008-2021**

|          |                 |
|----------|-----------------|
| CÓDIGO:  | <b>MXNV0600</b> |
| EQUIV 1: | DAKG21407Z      |
| EQUIV 2: |                 |
| OEM:     | 5U0 121 407     |



DEPOSITO ANTICONGELANTE C/TAPON (SAVEIRO 10-22/CROSSFOX 07-17)



**VK**

**JETTA A4 1.8L/2.0L 1999-2007**

|          |                 |
|----------|-----------------|
| CÓDIGO:  | <b>MXNV0110</b> |
| EQUIV 1: | DAKG21403B      |
| EQUIV 2: |                 |
| OEM:     | 1J0-121-407E/B  |



DEPOSITO ANTICONGELANTE C/TAPON (BETLE 98-11/GOLF A4 99-07/LEON 00-06)

# DEPOSITO ANTICONGELANTE



**VK**

## JETTA A4 1.8L/2.0L 1999-2007

|          |                 |
|----------|-----------------|
| CÓDIGO:  | <b>MXNV0111</b> |
| EQUIV 1: |                 |
| EQUIV 2: |                 |
| OEM:     | 1J0-955-453P    |



DEPOSITO LIMPIADORES C/TAPON S/MOTOR (GOLF A4 99-07/LEON-TOLEDO 00-06)



**VK**

## JETTA CLASICO 2.0L 2008-2015

|          |                 |
|----------|-----------------|
| CÓDIGO:  | <b>MXNV0120</b> |
| EQUIV 1: |                 |
| EQUIV 2: |                 |
| OEM:     | 1H0-121-407A    |



DEPOSITO ANTICONGELANTE C/TAPON S/SENSOR (POINTER GTI/GOLF A4/JETTA-GOLF A2-A3)



**VK**

## JETTA/GOLF A2/A3 1.8L/2.0L 1987-1998

|          |                 |
|----------|-----------------|
| CÓDIGO:  | <b>MXNV0100</b> |
| EQUIV 1: | DAKG21407A      |
| EQUIV 2: |                 |
| OEM:     | 1H0-121-407C/A  |



DEPOSITO ANTICONGELANTE C/TAPON (DERBY 95-00/POINTER 00-09)



**VK**

## LUPO/POLO 1.6L/2.0L 2003-2019

|          |                 |
|----------|-----------------|
| CÓDIGO:  | <b>MXNV1310</b> |
| EQUIV 1: | DAKG121407      |
| EQUIV 2: | *               |
| OEM:     | 6Q0-121-407B/A  |



DEPOSITO ANTICONGELANTE C/T (VENTO 14-22/IBIZA-CORDOBA 03-17/TOLEDO/SPORT VAN)



**VK**

## POINTER 1.8L 1998-2009

|          |                 |
|----------|-----------------|
| CÓDIGO:  | <b>MXNV0200</b> |
| EQUIV 1: |                 |
| EQUIV 2: |                 |
| OEM:     | 171-121-407E    |



DEPOSITO ANTICONGELANTE C/TAPON (CARIBE 77-87)